

April 2021



the **Blue Book** of  
etectable  
Products®  
Brought to you by Detectamet

The Blue Book of Detectable Products - April 2021



[detectamet.global](https://detectamet.global)



# Welcome to the Home of Detectable Products!

The **Blue Book of Detectable Products** is the place to find the greatest range of detectable products at the best prices! Established in 2003, Detectamet work with food, beverage and pharmaceutical manufacturers around the world to improve food safety and reduce the risk of foreign matter contamination.



## the **Blue Book** of etectable Products®

### Why do you need detectable products?

Food, beverage, and pharmaceutical industries need to prevent / reduce the risk of foreign body contamination.

Physical contaminants can damage equipment and cause injury. If they reach the consumer you will be faced with an expensive recall, which could seriously harm your reputation.

The safest way to eliminate and protect against this risk is to use metal detectable and X-ray visible products in all areas of your processing facility.



At Detectamet we take our business very seriously, which is why we are ISO accredited in:

9001: Quality Management

14001: Environmental Management

45001: Occupational Health and Safety Management



# The Blue Book of Detectable Products

## Product Innovation

Not content to stand still, our product development team are constantly developing new detectable products to help you avoid foreign body contamination.



**BRCGS** | In Partnership with

In our line of work it's imperative that our products contribute to making food production safer. This is why we work in partnership with BRCGS through their Partner Connection Programme.

# We have 5 sites globally, based in the UK, Germany, USA, Canada and Australia!

our global presence allows us to provide customer support 24 hours a day



## Product Development Specialists

At Detectamet, we have an agile product development team who regularly **design bespoke detectable products** for our customers. Please get in touch if you require a custom-made detectable product.



## Fabrication & Manufacturing Specialists

At Detectamet, we pride ourselves on our **development & manufacturing** of high quality **detectable products** for our **food, beverage and pharmaceutical** customers. This capability has recently been enhanced by investment in our **state-of-the-art injection moulding machines**.

We manage the **design and fabrication** of our product range and **regularly upgrade our products** to ensure they are as detectable and fit-for-purpose as possible.



If you require a detectable product that isn't currently listed in this catalogue, **please reach out to us**. We are likely to have the **capacity and expertise to design and manufacture** a product to suit your requirements.

### What do you get from Detectamet?

Detectamet's product range offers you the best in detectability, made from a unique, patented polymer that contains the highest level of detectable additive, without compromising on durability, and manufactured from EU & FDA (Food and Drug Administration) food contact approved materials.

- Unique polymer - contains highest levels of detectable additive on the market
- A large selection of products comply with EU and FDA food contact regulations
- Durable products - minimise risk of breaking and entering the food chain
- Largest range of detectable products on the market
- Colours - prevent cross contamination with nine strong, detectable colours available in many products. Blue, black, red, green, yellow, white, purple, orange and pink
- Bespoke products available on request
- Branding/sequential numbering with in-house laser engraver/pad printer
- Free samples available

## Stationery

Ink Types	10
Safety Chains and Split Ring Attachments	11
Pen Tethers	11
Fully Detectable Pen Refills Standard Ink	12
Fully Detectable Pen Refills Fine Tip Ink	12
Regular Pen Refills - Standard Ink	13
Regular Pen Refills - Cryo Ink	13
Regular Pen Refills - Gel Ink	13
Fully Detectable Economy Pen Refills	14
Retractable Highlighter Refills	14
Pen Codes	15
Heavy Duty Retractable Pens	16
Elephant Retractable Pens	17
Elephant One-Piece Pens	18
HD One-Piece Pens	19
Retractable Economy Pens	19
Retractable 4 in 1 Pens	20
Long Writing Pens	20
Stainless Steel Stick Pens	21
Retractable Stainless Steel Pens	21
Retractable Permanent Markers	22
Retractable Highlighters	23
Retractable Whiteboard Markers	23
Retractable Permanent Fine Markers	24
Retractable Food and Meat Markers	24
How to use Detectamet's Marker Retraction System	25
Pen Dispenser	25
Permanent Markers	26
Highlighters	26
Whiteboard Markers	27
Permanent Fine Markers	27
PDA Styluses	28
Touch Screen Pens	28
Whiteboard Eraser	29
Magnetic Pen Holders	29
Mechanical Pencils	29
Easy Grip Pen Sleeve	29
Swipe Card Holders	30
Fully Detectable Lanyards	31
Fully Detectable Wrist Strap	32
Desktop Calculator	33
Handheld Calculator	33
Calculator Holder	33
Phone & Tablet Cases	34
Food Temperature Probe	34
Timer	35
Temperature Probe Holder	35
Stopwatch	35
Scissors	36
Scissor Holders	37
Mouse Mat	37
Utility Pouch	38
Tape Measure	39

Rulers	39
Badge Reels	39
Safety Chains & Split Rings	40
Paper Clips	40
Staple-Free Stapler - 7 sheets	40
Staple-Free Stapler - 10 sheets	41
Crimper	41
Staple-Free Staplers - 5 sheets	42
Paper	42
Clipboard Options	45
Design Your Own Clipboard	46
Aluminium or Stainless Steel Clipboard	48
Plastic Clipboard	49
Hanging Hooks	50
Economy Clipboard Clips	50
Heavy Duty Clipboard Clips	51
Jumbo Chrome Plated Clips	51
Bulldog / Bag Clips	52
Serrated Edge Clips	53
Zinc Plated Clips with Pen Holders	53
Jaw Clips	53
Magnetic Clipboard	54
Hanging Clipboard	55
Ring Binder Clipboard	56
Magnetic Multi-Purpose Holders	56
Chrome Ring Binder Mechanisms	57
Ring Binder	58
Lever Arch File	59
Wall Mountable Document Holder	60
Envelope Style Document Holder	61
Aluminium Flip Chart	61
Stickers	63
Wall Mounted File Pocket	64
Recipe Holder	65
"Cling Easy" Whiteboard Material	65
Multi-Purpose Utility Stand	66
Storage Clipboard	66
File Holder	67
File Holder with Hanging Hook	68
Filing Tray	68

## Workwear & PPE

Vinyl Gloves	70
Rubber Gloves	70
Nitrile Gloves with Seamless Cuffs	72
Nitrile Gloves with Woven Cuffs	73
Reusable Nitrile Gloves	74
Stainless Steel Glove Dispenser	75
Plastic Glove Dispenser	76
Plasters/Bandages	77
Reusable Earplugs 2 or 3 Flange	78
Reusable Earplugs 3 Flange	79
Reusable Earplugs 'Clean Ear' System	80
Expandaband	81
Earplug Box	82

# Contents

Disposable Ear Plugs	82
Ear Plug Dispenser	83
Face Shields	84
Beard Snoods	86
Balaclava Hoods Mob/Bouffant Caps	87
Hairnets	88
Hairnets with Neck Guard	89
Disposable Aprons	90
Reusable Apron	90
Disposable Sleeve Covers	91
Reusable Sleeve Covers	91
Shoe Covers	92
Glove Tensioners	92
Rubber Bands	92
Litter-Free Wristband	93
Lightweight Safety Glasses	94
Ultra Lightweight Safety Glasses	94
Lightweight Over Glasses	94
Glasses Cord	94
Utility Clips	96
Ear Savers	97
Face Mask Spacer / Bracket	98
Face Coverings	99
Face Mask Dispenser	100
Multi-Purpose Dispenser	101

## 6

### Storage, Mixing & Handling

Utility Hook	104
Flexible or Rigid Scraper	105
Flexible Scrapers	106
Serrated Edge Flexible Scrapers	106
Mini Spatulas	107
Gasket Scraper & Dough Cutter	107
Scraper with Stainless Steel or Brass Blade	108
Hand Scrapers	109
Bench Scraper & Small Scraper	110
Stirrer/Scraper	110
Square Scoops	111
Round Bowl Scoops	112
Flour Scoops	113
Pouring Jug & Scooping Jug	114
Jug with Lid	115
Measuring Cups & Measuring Spoons	115
Sampling Cutlery & Sampling Cups	115
Sampling Beakers	116
Prover Pocket	116
Bucket with Lid	116
Bucket without Handle	117
Storage Box & Containers	117
Disinfectant Wipe Dispenser	118
Dustpan	118
Shadow Board	119
Storage Tray with Lid	120
Double Sided Tape	121

Detectortape	121
Disinfectant & Probe Wipe Dispenser Holder	122
Trigger Sprayer & Wipe Dispenser Holder	123
Shelf	124
Sanitiser Bottle Holder	125
Plastic/Steel Paper Towel Holder	125
Shovel	126
Paddle without Holes	127
Large Paddle	127
Scouring Pad & Spray Bottle	128
Resin-Set Brushes	129
Resin-Set Hand Brush with Medium Bristles	129
Resin-Set Long Handled Brush	130
Resin-Set Hand Brush with Stiff Bristles	130
Resin-Set Nail Brush	130
Brushes & Brooms	131
Hand Brush	131
Hand Brush with Long Handle	132
Nail Brush	132
Cylinder Brush	132
Cylinder Brush for Long Handle	133
Round Hand Brush	133
Large Hand Brush	133
Short Handled Brush	133
Dish Brush & Floor Brush	134
Push Broom	134
Tabletop Squeegee	134
Floor Squeegee & Floor Scraper	135
Handles	135
Health & Safety Signs & Floor Stickers	136
Floor Signs	137
Stainless Steel Shovels and Spades	138
Stainless Steel Paddles & Forks	138
Stainless Steel Scoops	139
Stainless Steel Pharma Scoops	139
Stainless Steel Pails	140
Stainless Steel Bucket with Lid	141
Stainless Steel Whisk & Bowl	141
Stainless Steel Measuring Jug	142
Stainless Steel Funnel	142
Tote Bin Cover Dispenser	143
Tote Bin Covers	144
Extra Large Tote Bin	145
Extra Large Tote Bin Covers	145
Polythene Bags & Liners	146
Pallet Wrap & Pallet Band	147
Bag Grippers	147
Bag Closure Grips	147

### Tags, Labels & Seals

Lot Dividers	149
Keyhole Loop Tags	150
Tag Dispenser	151

Reusable/Releasable Nylon Cable Ties	152
Nylon Cable Ties	152
Nylon Cable Ties with Stainless Steel Lock	153
Polypropylene Cable Ties with Stainless Steel Lock	153
Cable Tie Mounts	154
Cable Identification Tags	154
Cable Organiser	154
Cable Clamps	154
Security Seals	155
Security Seals with Sequential Numbering	156
Circular Identification Tags	157
Looped Identification Tags	157
Identification and Lockout Tags	157
Shadow Boards & Accessories	158-160

## Safety Knives

Replacement Blades	161
Safety Knife Applications	162
Safety Knife Features	163
Disposable Safety Knives	164
Disposable Safety Knives with Hook Blade	164
Disposable Safety Knives with Enclosed Blades and Tape Cutter	165
Disposable Bag Cutters with Enclosed Blade	165
Disposable Safety Knives with Dual Enclosed Blades	166
Disposable Safety Knives with Enclosed Blade and Hook Blade	166
Disposable Safety Knives with Enclosed Blade and Tape Cutter	167
Disposable Plastic Sheet Cutters with Enclosed Blade	167
Disposable Safety Knives with Enclosed Blade	168
Disposable Ring Safety Knives	168
Normal Duty Safety Knife	169
Normal Duty Safety Knife with Enclosed Blade and Tape Cutter	169
Normal Duty Safety Knives	170
Normal Duty Safety Knives with Dual Enclosed Blades and Tape Cutter	170
Normal Duty Stainless Steel Safety Knife with Auto Retracting Blade	170
Heavy Duty Aluminium Safety Knife	171
Heavy Duty Detectable Safety Knife	172
Heavy Duty Detectable Steel Safety Knife with Enclosed Blade	172
Heavy Duty Detectable Safety Knives with Enclosed Blade	173
Heavy Duty Detectable Box Cutter	173
Lambfoot Blade	174
Sheepfoot Blade	174
Clip Point Blade	174
Pruning Blade	175
All Purpose Blade	175
Pruning Blade	175
Drop Point Blade	175

## Professional Knives

Vegetable Knives	178
Chef's Knives	178
Boning Knives	179
Turning Knives	179
Paring Knives	180
Broad Flex Filleting Knives	180
Butcher's Knives	181
Dough Knives	181
Wavy Edge Slicers	182
Pallet Knives	182
Bread/Pastry Knives	182
Chopping Board	182
Security Cage	183

## Engineering & Test Pieces

Mallet	185
Mallet with Screw-in Faces	186
Test Pieces	187
Detectasil	191
UHMWPE	192
O-Ring	193
Acetal	193
Silicone Rubber Sheeting, Strips and Extrusions	194
PTFE	194
Polyurethane Belting	195
PA6 Filled Nylon	195
PEEK	196
Mat	196
Floor Signs & Floor Sticker Signs	197

## Index 198



# Detectable Kit Pack

FR: Pack de kit détectable

ES: Paquete de kit detectable

DE: Erkennbares Kit-Pack

Our detectable kit pack is a great way to get your staff equipped with everything they might need to work safely and effectively in a food or pharmaceutical processing environment. To enhance traceability, sequential numbering of each product is also available upon request.

Get your employees safely equipped with our detectable kit pack!

15 Items Per Pack



DETECTABLE EARPLUG STORAGE BOX



DETECTABLE EAR SAVER



DETECTABLE PAPER CLIP

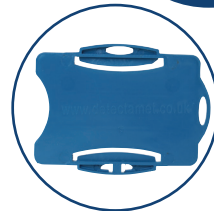

DETECTABLE CARD HOLDER



DETECTABLE EARPLUGS

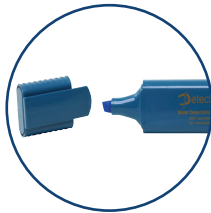

DETECTABLE HIGHLIGHTER



DETECTABLE REUSABLE RUBBER GLOVES



DETECTABLE FACE VISOR



DETECTABLE STOPWATCH

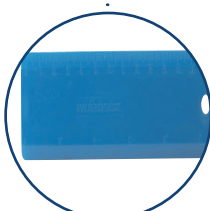

DETECTABLE RULER



DETECTABLE LANYARD



DETECTABLE HD PEN



DETECTABLE WHITEBOARD MARKER



DETECTABLE PERMANENT MARKER



New Product!

Detectable Kit Pack

PRODUCT CODE: KIT

# Metal Detectable & X-Ray Visible Stationery



**FR:** Papier à lettres

**ES:** Papelería

**DE:** Schreib- und Papierwaren





Ink Types	10	Permanent Fine Markers	27	Design Your Own Clipboard	46
Safety Chains and Split Ring Attachments	10	PDA Styluses	28	Aluminium or Stainless Steel Clipboard	48
Pen Tethers	11	Touch Screen Pens	28	Plastic Clipboard	49
Fully Detectable Pen Refills Standard Ink	12	Whiteboard Eraser	29	Hanging Hooks	50
Fully Detectable Pen Refills Fine Tip Ink	12	Magnetic Pen Holders	29	Economy Clipboard Clips	50
Regular Pen Refills - Standard Ink	13	Mechanical Pencils	29	Heavy Duty Clipboard Clips	51
Regular Pen Refills - Cryo Ink	13	Easy Grip Pen Sleeve	29	Jumbo Chrome Plated Clips	51
Regular Pen Refills - Gel Ink	13	Swipe Card Holders	30	Bulldog / Bag Clips	52
Fully Detectable Economy Pen Refills	14	Fully Detectable Lanyards	31	Serrated Edge Clips	53
Retractable Highlighter Refills	14	Fully Detectable Wrist Strap	32	Zinc Plated Clips with Pen Holders	53
Pen Codes	15	Desktop Calculator	33	Jaw Clips	53
Heavy Duty Retractable Pens	16	Handheld Calculator	33	Magnetic Clipboard	54
Elephant Retractable Pens	17	Calculator Holder	33	Hanging Clipboard	55
Elephant One-Piece Pens	18	Phone & Tablet Cases	34	Ring Binder Clipboard	56
HD One-Piece Pens	19	Food Temperature Probe	34	Magnetic Multi-Purpose Holders	56
Retractable Economy Pens	19	Timer	35	Chrome Ring Binder Mechanisms	57
Retractable 4 in 1 Pens	20	Temperature Probe Holder	35	Ring Binder	58
Long Writing Pens	20	Stopwatch	35	Lever Arch File	59
Stainless Steel Stick Pens	21	Scissors	36	Wall Mountable Document Holder	60
Retractable Stainless Steel Pens	21	Scissor Holders	37	Envelope Style Document Holder	61
Retractable Permanent Markers	22	Mouse Mat	37	Aluminium Flip Chart	61
Retractable Highlighters	23	Utility Pouch	38	Stickers	63
Retractable Whiteboard Markers	23	Tape Measure	39	Wall Mounted File Pocket	64
Retractable Permanent Fine Markers	24	Rulers	39	Recipe Holder	65
Retractable Food and Meat Markers	24	Badge Reels	39	"Cling Easy" Whiteboard Material	65
How to use Detectamet's Marker Retraction System	25	Safety Chains & Split Rings	40	Multi-Purpose Utility Stand	66
Pen Dispenser	25	Paper Clips	40	Storage Clipboard	66
Permanent Markers	26	Staple-Free Stapler - 7 sheets	40	File Holder	67
Highlighters	26	Staple-Free Stapler - 10 sheets	41	File Holder with Hanging Hook	68
Whiteboard Markers	27	Crimper	41	Filing Tray	68
		Staple-Free Staplers - 5 sheets	42		
		Paper	42		
		Clipboard Options	45		

## Detectamet work in partnership with BRCGS through the Partner Connection Programme

Our pens are made from shatter resistant FDA/EU Food grade materials which contain a detectable additive, making them detectable by foreign body detection equipment, and are designed without small parts that can break off and enter the food chain.

### Ink Types

Detectamet's pens and refills come in four different types of ink and **it's important you choose the right ink for the correct working environment**. Standard inks are not suitable for cold and wet areas.

Ink type	Which environment is it suitable for?	Available colours	Notes
<b>Standard</b>	Ambient conditions 0°C up to 30°C (32 to 86°F). Writing line width 1mm (39.4 mils)		
<b>Pressurised Cryo</b>	Extreme colds -15°C up to 60°C (5 to 140°F) E.g. freezers/cold stores; wet areas; powdery surfaces; greasy surfaces, underwater, writes upside down. Writing line width 1.2mm (47.2 mils) Unlimited shelf life		<i>Due to the pressurised nature which maintains a consistent ink flow, it's important to clean the nib frequently to limit the build-up of ink</i>  <i>Unlimited shelf life</i>
<b>Fine tip</b>	Ambient conditions. Writing line width 0.7mm (27.6 mils)		
<b>Gel</b>	Ambient conditions -5°C up to 30°C (23 to 86°F); cold environments; dusty environments. Writing line width 0.7mm (27.6 mils)		

### Safety Chains and Split Ring Attachments



Retractable markers are unique and can easily get lost, so why not have safety chains and split ring attachments fitted to your pens?

To order use product codes:

Split Ring	153-T203
Safety Chain	155-P44-S083-A93





## Metal Detectable & X-Ray Visible Pen Tether

FR: Attache de stylo  
ES: Cuerda de la pluma  
DE: Stiftband

500mm (19.68") safety chain with split ring and clip at either end. Ideal for attaching to a clipboard, ring binder or anchor point on a desk or wall.

PROVIDED WITH  
CLIP AND SPLIT  
RING AT EITHER  
END

New  
Product!



### Features & Options

10  
PACK

Made In:  
UK USA

500MM (19.68")  
SAFETY CHAIN  
TO ATTACH TO A  
CLIPBOARD, RING  
BINDER OR ANCHOR  
POINT ON A DESK  
OR WALL

Colour:

PRODUCT CODE: 153-T567

Sequential numbering available for all products • Ask us for a pen and knife guide

## Metal Detectable & X-Ray Visible Pen Tether with Detectable Pen Grip

FR: Attache de stylo  
ES: Cuerda de la pluma  
DE: Stiftband

500mm (19.68") safety chain with split ring and clip at one end, and a detectable pen grip at the other end to support pens that do not have a clip to fasten.

Ideal for attaching to a clipboard, ring binder or anchor point on a desk or wall.

WITH DETECTABLE PEN GRIP  
ATTACHED TO SPLIT RING

New  
Product!



### Features & Options

10  
PACK

Made In:  
UK USA

500MM (19.68")  
SAFETY CHAIN  
TO ATTACH TO A  
CLIPBOARD, RING  
BINDER OR ANCHOR  
POINT ON A DESK  
OR WALL

Colour:

Pen Grip Colour:

PRODUCT CODE: 153-T568

# Pen Refills



**We sell refills!**

## Fully Detectable Pen Refills





Our patent pending pen refills were the first on the market to be fully detectable, including the end cap.

### Features & Options

**100  
PACK**



#### Ink type: standard

Colour	Product Code
	100-I51
	100-I52
	100-I53
	100-I54

**MANUFACTURED FROM  
DETECTABLE SHATTER  
PROOF PLASTIC**

#### Ink type: fine tip

Colour	Product Code
	100-I71
	100-I72

**WRITE OUT LENGTH  
APPROX. 9,400M  
(30,840')**

**FULLY DETECTABLE -  
INCLUDING END CAP**

#### Available for:

- HD retractable pen
- Elephant retractable pen
- Stainless steel retractable pen
- Metal stick pen



# Pen Refills

## Regular Pen Refills

Manufactured from stainless steel and non-detectable shatter proof plastic.

Partially detectable – doesn't include end cap.

We sell refills!

100  
PACK

### Features & Options



**Ink type: standard**

**Write out length approx: 9,400m (30,840')**

Colour	Product Code
	100-I03





**Ink type: cryo**

**Write out length approx: 6,000m (19,685')**

Colour	Product Code
	100-I11
	100-I12

**Ink type: gel**

**Write out length approx: 850m (2,788')**

Colour	Product Code
	100-I21
	100-I22
	100-I23
	100-I24

**Available for:**

- HD retractable pen
- Elephant retractable pen
- Stainless steel retractable pen
- Metal stick pen



In Partnership  
with  
**BRCGS**

13

**Detectamet**

# Pen Refills

## Fully Detectable Economy Pen Refills





These fully metal & X-ray detectable stick pen refills are suitable for our retractable economy pens.

### Features & Options

**100  
PACK**

**Ink type: standard**

**Write out length approx: 9,400 m (30,840')**

Colour	Product Code
	117-I01
	117-I02
	117-I03
	117-I04

**MANUFACTURED  
FROM METAL**

**Available for:**

- Retractable economy pen



## Retractable Highlighter Refills







These non-detectable highlighter refills have been designed to extend the life of your detectable retractable highlighters.

### Features & Options

**5  
PACK**

**Ink type: standard**

**Write out length approx: using tip only 300 m (984')**

Colour	Product Code
	156-P01-A08
	156-P04-A08
	156-P05-A08
	156-P08-A08
	156-P09-A08
	156-ASSORTED

**Available for:**

- Retractable highlighter pen

**CHISEL TIP**

**NON-DETECTABLE**



# Pen Codes

We understand product codes can be confusing, as we offer such a wide range of pens. Please see the guide below to show how to work out the code for our most popular pens.

If you are uncertain in any way, please talk to our sales team for guidance.

## HD and Elephant Retractable Pens

E.g. 101-I01-C11-PA01 **HD Retractable pen** with **blue standard ink**, **blue housing** and **blue end cap with clip**

TYPE OF PEN		TYPE TYPE		INK COLOUR	HOUSING COLOUR	CAP COLOUR	CLIP TYPE	
101	HD Retractable	I0	Standard	1	C1	1	PA01	with clip
104	Elephant Retractable	I1	*Cryo	2	C2	2	PA02	without clip
		I2	Gel	3	C3	3	PA03	lanyard
		I3	*Fine tip	4	C4	4		
					C5	5		
					C6	6		
					C7	7		
					C8	8		
					C9	9		

\*Cryo and Fine Tip ink only available in blue and black

## Elephant One-Piece Pens

Only available with standard ink and no cap.

E.g. 105-C101-I01-PA01 **Elephant One-Piece pen** with **blue housing**, **blue standard ink**, with clip

TYPE OF PEN	HOUSING COLOUR	INK COLOUR	CLIP TYPE
105   Elephant One-Piece	C101	I01	PA01   with clip
	C110	I02	PA02   without clip
	C103	I03	PA03   lanyard
	C104	I04	
	C105		
	C160		
	C107		
	C108		
	C109		

## HD One-Piece Pens

Only available with standard ink and no cap.

E.g. 116-I02-C103-PA03 **HD One-Piece pen** with **black standard ink**, **red housing** with lanyard

TYPE OF PEN	INK COLOUR	HOUSING COLOUR	CLIP TYPE
116   HD One-Piece	I01	C101	PA01   with clip
	I02	C110	PA02   without clip
	I03	C103	PA03   lanyard
	I04	C104	
		C105	
		C160	
		C107	
		C108	
		C109	

# Heavy Duty (HD) Retractable Detectable Pens

FR: Stylo rétractable robuste ES: Bolígrafo retráctil de alta resistencia DE: Extrastarker Druckkugelschreiber

These are our best-selling retractable metal detectable and X-ray visible pens, designed to be extremely durable and shatter proof – minimising any risk of foreign body contamination.

Made from Detectamet's unique detectable polymer, the rugged construction makes it resilient, so it won't break under stress, whilst the ergonomic grip allows a firm hold in a wide range of environments.

## Features & Options

**50  
PACK**

### INK COLOURS



(Pressurised cryo & fine tip: blue & black only)

### INK TYPES

- standard
- cryo
- gel
- fine tip

### RETRACTABLE

No need for a cap!



### HOUSING COLOURS



**Refillable**

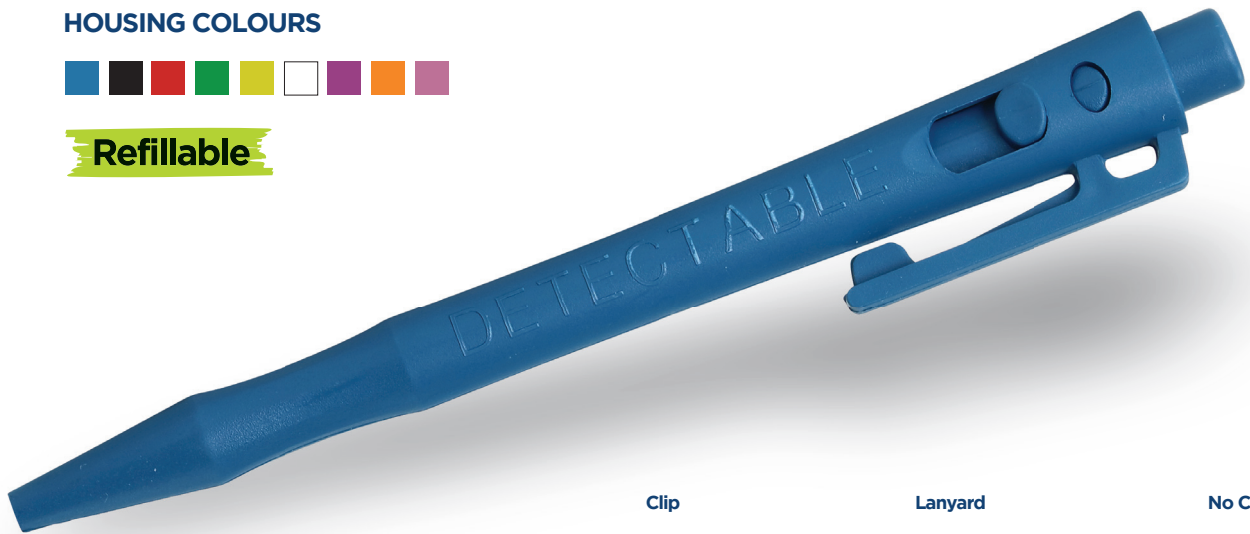

Clip



Lanyard



No Clip



**ERGONOMIC WITH  
INDENTED GRIP**

**FULLY  
DETECTABLE  
REFILL  
AVAILABLE**

(for standard/fine tip inks), Regular refill (for cryo, gel inks)

**SHATTER PROOF AND  
VIRTUALLY UNBREAKABLE**





# Retractable Detectable Pens

FR: Stylo rétractable éléphant ES: Bolígrafo retráctil Elefant DE: Druckkugelschreiber Elefant

Each component is metal detectable and X-ray visible and is specifically designed for the food safety industry to minimise risk of foreign body contamination from parts breaking off and entering the food chain.

As with all Detectamet's products, it's shatter proof and incredibly durable, and to minimise your environmental footprint it can be filled with a fully detectable refill to extend its life.



## Features & Options



### INK COLOURS



(Pressurised cryo & fine tip: blue & black only)

### INK TYPES

- standard
- cryo
- gel
- fine tip

### RETRACTABLE

No need for a cap!



### HOUSING COLOURS



**Refillable**

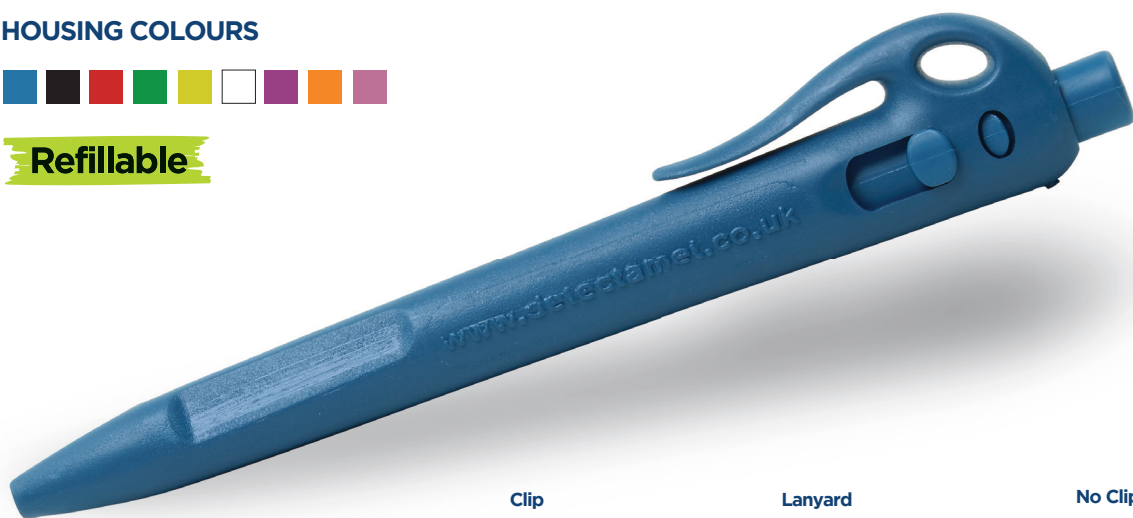

**TRIANGULAR TEXTURED SURFACE FOR ENHANCED GRIP**

**FULLY DETECTABLE REFILL AVAILABLE**

(for standard/fine tip inks), Regular refill (for cryo, gel inks)

**SHATTER PROOF AND VIRTUALLY UNBREAKABLE**



In Partnership with  
**BROGS**

17

**Detectamet**

**PRODUCT CODE: 104-I**



# Detectable One-Piece Pens

FR: Stylo éléphant ES: Bolígrafo Elephant DE: Kugelschreiber „Elefant“

Part of Detectamet's range of detectable pens, Elephant stick pens are made in the UK using our unique detectable polymer.

With its clever one-piece design, it significantly reduces the chance of foreign body contamination.

They are a cost-effective solution for use in open product areas and, as with all Detectamet's products, they are shatter proof and extremely durable.



## Features & Options

### ONE-PIECE PEN

No small parts, minimises risk of contamination

### HOUSING COLOURS



SHATTER PROOF AND VIRTUALLY UNBREAKABLE

### INK COLOURS



### INK TYPES

- Standard

SUITABLE FOR PAD PRINTING / LASER ENGRAVING



TRIANGULAR TEXTURED SURFACE FOR ENHANCED GRIP

Clip



Lanyard



No Clip

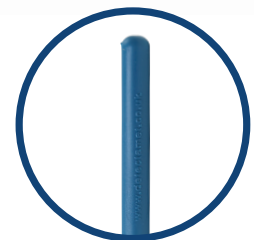

MANUFACTURED FROM EU & FDA FOOD CONTACT APPROVED MATERIALS

PRODUCT CODE: 105-C



## Metal Detectable & X-Ray Visible HD One-Piece Pens

FR: Stylo robuste

ES: Bolígrafo de alta resistencia

DE: Extrastarker Kugelschreiber

Heavy duty, one-piece stick pens are an economical writing solution and perfect for where a one-piece pen is stipulated.



### Features & Options

50  
PACK

End type:

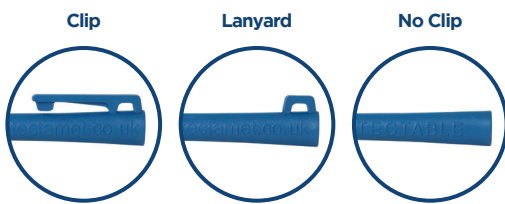

Housing:

Ink:

Ink type: Standard

CONTAINS A ONE-PIECE REFILL

PRODUCT CODE: 116-10

Sequential numbering available for all products • Ask us for a pen and knife guide

## Metal Detectable & X-Ray Visible Retractable Economy Pens

FR: Stylos économiques rétractables

ES: Bolígrafos retráctiles económicos

DE: Stifte, rückziehbar

These retractable economy pens are ergonomic, with ridges at the point of grip, and come in four different ink colours.

### Features & Options

50  
PACK

End type:

- Clip

Housing:

Ink:

Ink type: Standard

END CAP MATCHES INK COLOUR

Refillable



PRODUCT CODE: 125-P01-10

## Metal Detectable & X-Ray Visible Retractable 4 in 1 Pens

FR: 4 en 1 stylo multi couleur détectable

ES: 4 en 1 pluma detectable multicolor

DE: 4 in 1 mehrfarbiger Stift

These four in one retractable pens come in standard blue housing and will ensure you always have the right colour ink for the task in hand.

### Features & Options

10  
PACK

#### End type:

- Clip

#### Housing:



#### Ink:



Ink type: Standard



4 INK COLOURS  
IN ONE

SUITABLE  
FOR  
PAD PRINTING

Refillable



PRODUCT CODE: 108-A05

Sequential numbering available for all products • Ask us for a pen and knife guide

## Metal Detectable & X-Ray Visible Long Writing Pens

FR: Plus long marqueur détectable d'écriture

ES: Pluma detectable de escritura mas larga

DE: Längster Schreibbarer Detektierbarer Stift

If you are looking for pens with long lasting ink, then these are the ones for you, with both lid and housing being detectable.

### Features & Options

10  
PACK

#### End type:

- Clip

#### Housing:



#### Ink:



Ink type: Standard

WRITING  
DISTANCE: 12.5KM  
(7.8 MILES)

SUITABLE FOR  
PAD PRINTING

Refillable



PRODUCT CODE: 149-A06

## Metal Detectable & X-Ray Visible Stainless Steel Stick Pens

FR: Stylos métalliques

ES: Bolígrafos metálicos

DE: Metallkugelschreiber

Metal one-piece stick pens are robust, hard wearing and manufactured from two different types of metal to increase detectability.

**Refillable**

SUITABLE FOR PAD PRINTING/  
LASER ENGRAVING

### Features & Options

50  
PACK

#### End type:

Clip

Lanyard

No Clip



Housing:



Ink:



**Ink type:** Standard, cryo, fine tip, gel (cryo & fine tip only available in blue & black)



In Partnership  
with  
**BREGS**

**PRODUCT CODE:** 610

Sequential numbering available for all products • Ask us for a pen and knife guide

21

## Metal Detectable & X-Ray Visible Retractable Stainless Steel Pens

FR: Stylo en acier inoxydable

ES: Bolígrafo de acero inoxidable

DE: Kugelschreiber aus Edelstahl

Retractable stainless steel pens with chrome nibs / end cap with clip.

**Refillable**

10  
PACK

### Features & Options

#### End type:

• Clip

Cap:



Housing:



Ink:



**Ink type:** standard, cryo, fine tip, gel (cryo & fine tip only available in blue & black)

SUITABLE FOR PAD PRINTING/  
LASER ENGRAVING



etectamet

**PRODUCT CODE:** 114 (chrome)

# NEW Retractable Permanent Marker Pens

FR: Marqueur permanent fin rétractable  
ES: Marcador permanente fino retráctil  
DE: Wasserfester Marker mit feiner Spitze, rückziehbar

**Best Seller!**

Our unique retractable housing design contains the refill. No cap to lose!

Robust, non-toxic, detectable permanent marker pens for writing on all surfaces - suitable for use in all food production environments.

## Features & Options

**10 PACK**

**METAL DETECTABLE**

**X-RAY VISIBLE**

HOUSING COLOUR



INK COLOURS



RETRACTABLE

No need for a cap!

**New Design for 2021!**



TIP STYLE



Bullet



Chisel

SHATTER PROOF AND VIRTUALLY UNBREAKABLE

MANUFACTURED FROM EU & FDA FOOD CONTACT APPROVED MATERIALS

**PRODUCT CODE: 146-N-A05**

In Partnership with **BROS**

22



**etectamet**

## Metal Detectable & X-Ray Visible Retractable Highlighters

FR: Surligneurs rétractables  
 ES: Resaltadores retráctiles  
 DE: Rückziehbare Leuchtstifte

These retractable highlighters have blue housing, are available in five ink colours, or as an assorted pack of ink colours.

### Features & Options 5 PACK

- Housing:** 
- Ink:** 
- Ink type:** Standard
- Tip style:**



SUITABLE FOR PAD  
 PRINTING/ LASER  
 ENGRAVING

Refillable



**PRODUCT CODE:** 150-A05



More product codes available – please contact us for a full price list

## NEW Metal Detectable & X-Ray Visible Retractable Whiteboard Markers

FR: Marqueur pour tableau blanc rétractable  
 ES: Marcador retráctil para pizarra blanca  
 DE: Whiteboard-Marker, rückziehbar

Retractable whiteboard markers that come in blue housing with a bullet or chisel tip, available in four ink colours, or as an assorted pack of ink colours.

### Features & Options 10 PACK

- End type:**
- Clip
- Housing:** 
- Ink:** 
- Ink type:** Standard
- Tip style:**



**New  
 Design  
 for 2021!**

SUITABLE FOR PAD  
 PRINTING/ LASER  
 ENGRAVING

CAN BE DRILLED WITH  
 A HOLE TO FIT SPLIT  
 RING FOR ATTACHING  
 TO A SAFETY CHAIN/  
 LANYARD (additional  
 charge applicable)



**PRODUCT CODE:** 145-N-A05



## Metal Detectable & X-Ray Visible Retractable Permanent Fine Markers

FR: Marqueur permanent fin rétractable

ES: Marcador permanente fino retráctil

DE: Wasserfester Marker mit feiner Spitze, rückziehbar

These permanent retractable fine markers are available in four ink colours, or as an assorted pack of ink colours.

### Features & Options

10  
PACK

#### End type:

- Clip

#### Housing:



#### Ink:



Ink type: Standard

WRITING LINE WIDTH  
0.55 MM (21.7MILS)

SUITABLE FOR PAD PRINTING /  
LASER ENGRAVING



PRODUCT CODE: 147-A05

Sequential numbering available for all products • Ask us for a pen and knife guide

## Metal Detectable & X-Ray Visible Retractable Food and Meat Markers

FR: Marqueurs rétractables pour les aliments ou la viande

ES: Marcadores retráctiles para limentos o carnes

DE: Drucksignierstift für Lebensmittel und Fleisch

These retractable food and meat markers come in blue housing with four ink colours and use food safe ink which is quick drying to prevent bleeding on the product.

### Features & Options

10  
PACK

#### End type:

- Clip

#### Housing:



#### Ink Food:



#### Ink Meat:



Ink type: Standard

Tip style: Bullet



Bullet



CAN BE DRILLED  
WITH A HOLE TO  
FIT SPLIT RING FOR  
ATTACHING TO A  
SAFETY CHAIN/  
LANYARD (additional  
charge applicable)

SUITABLE FOR PAD PRINTING/  
LASER ENGRAVING



PRODUCT CODE: 148-TO41 (meat), 148-TO40 (food)

# Metal & X-Ray Detectable Pen Holder & Dispenser

FR: Distributeur de stylo  
 ES: Dispensador de bolígrafo  
 DE: Stiftspender



Our wall mountable metal and X-ray detectable pen holders & dispensers keep our detectable pens organised & accessible. If you require a custom stationery holder, please get in touch!

## Features & Options

New Products!

1 PACK



STATIONERY HOLDER  
 BESPOKE DESIGN  
 UPON REQUEST

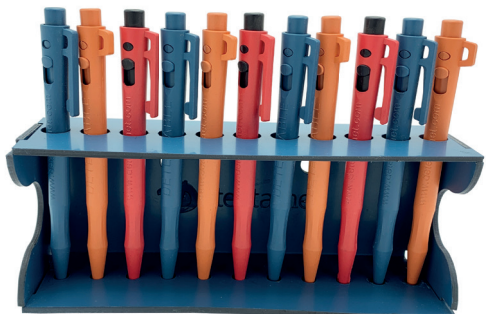

ELEPHANT  
 PEN HOLDER

HD PEN  
 HOLDER

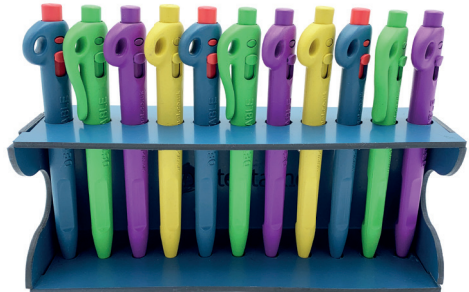

Colours:

**PEN DISPENSER PRODUCT CODE: 431-A241**  
**ELEPHANT PEN HOLDER PRODUCT CODE: 159E**  
**HD PEN HOLDER PRODUCT CODE: 159H**  
**STATIONERY HOLDER PRODUCT CODE: 159**

In Partnership with  
**BROGS**

25

**etectamet**

## NEW Metal Detectable & X-Ray Visible Permanent Markers

FR: Marqueur permanent fin rétractable  
 ES: Marcador permanente fino retráctil  
 DE: Wasserfester Marker mit feiner Spitze, rückziehbar

These non-retractable permanent markers come in blue housing with a bullet or chisel tip. Supplied either with a lanyard clip or without a clip.

AVAILABLE WITH OR WITHOUT LANYARD CLIP

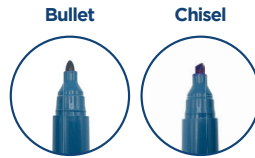

New Design for 2021!

### Features & Options

10 PACK

- End type:**
- No Clip
  - Lanyard Clip
- Housing:** [Blue square]
- Ink:** [Blue square] [Black square] [Red square] [Green square]
- Ink type:** Standard
- Tip style:** Bullet or Chisel



LID ATTACHES TO END OF PEN



SUITABLE FOR PAD PRINTING/LASER ENGRAVING

PRODUCT CODE: 146-N-A06

Sequential numbering available for all products • Ask us for a pen and knife guide

## Metal Detectable & X-Ray Visible Highlighters

FR: Surligneurs  
 ES: Resaltadores  
 DE: Leuchtstifte

These non-retractable highlighters have blue housing, are available in five ink colours, or as an assorted pack of ink colours.

SUITABLE FOR PAD PRINTING/LASER ENGRAVING



Chisel

### Features & Options

5 PACK

- Housing:** [Blue square]
- Ink:** [Blue square] [Green square] [Purple square] [Orange square] [Yellow square]
- Ink type:** Standard
- Tip style:** Chisel



CLIP



PRODUCT CODE: 150-A06



## NEW Metal Detectable & X-Ray Visible Whiteboard Markers

FR: Marqueur pour tableau blanc non rétractable

ES: Marcador no retráctil para pizarra blanca

DE: Whiteboard-Marker, nicht rückziehbar

These non-retractable permanent markers come in blue housing with a bullet or chisel tip. Supplied either with a lanyard clip or without a clip.

### Features & Options

10  
PACK

#### End type:

- No Clip
- Lanyard Clip

#### Housing:



#### Ink:



Ink type: Standard

AVAILABLE  
WITH OR  
WITHOUT  
LANYARD CLIP



Bullet

Chisel



New  
Design  
for 2021!



LID ATTACHES TO END OF PEN



SUITABLE FOR PAD PRINTING/LASER ENGRAVING

PRODUCT CODE: 145-N-A06

More product codes available – please contact us for a full price list

## Metal Detectable & X-Ray Visible Permanent Fine Markers

FR: Marqueur permanent fin

ES: Marcador permanente fino

DE: Wasserfester Marker mit feiner Spitze

These permanent non-retractable fine markers are available in four ink colours, or as an assorted pack of ink colours.

### Features & Options

10  
PACK

#### End type:

- Clip

#### Housing:



#### Ink:



Ink type: Standard

WRITING LINE WIDTH  
0.55 MM (21.7 MILS)



SUITABLE FOR PAD  
PRINTING/LASER  
ENGRAVING

PRODUCT CODE: 147-A06

## Metal Detectable & X-Ray Visible PDA Styluses

FR: Stilet de PDA  
ES: Lápiz digital para PDA  
DE: PDA-Stift

These touch screen styluses are manufactured from fully detectable plastic and perfect for use on PDA screens.

**New Design for 2021!**

**NON-SCRATCHING**

**Made In: UK**

### Features & Options

10 PACK

#### End type:

- Clip

#### SIZE:

Length: 98 mm (3.85")  
Diameter: 7 mm (0.27")

**ONLY SUITABLE FOR NON-CAPACITIVE SCREENS**

Colours: 

**PRODUCT CODE:** 122P-PO

Sequential numbering available for all products • Ask us for a pen and knife guide

## Metal Detectable & X-Ray Visible Touch Screen Pens

FR: Stylo pour écran tactile  
ES: Bolígrafo para pantalla táctil  
DE: Touchscreen-Stift

Detectable pen and stylus in one! Sold in packs of 10. Stylus is suitable for capacitive screens such as tablets & smartphones.

### Features & Options

10 PACK

#### End type:

- Clip

Housing: 

Ink: 

Ink type: Standard

**STYLUS END IS SUITABLE FOR ALL CAPACITIVE SCREENS**

**PRODUCT CODE:** 121-T202



## Metal Detectable & X-Ray Visible Whiteboard Eraser

FR: Support pour marqueurs  
 ES: Portamarcadores  
 DE: Markierstifthalter

1  
PACK

A whiteboard eraser with space to securely hold two whiteboard markers, allowing you to keep everything in one place.



\*Pens not included

### Features & Options

- Metal detectable
- X-Ray visible
- Magnetic strip adheres to metallic whiteboard surface
- Pen holders suitable for both retractable/non retractable markers
- Suitable for pad printing/laser engraving

**PRODUCT CODE:** 305-S642

## Metal Detectable & X-Ray Visible Magnetic Pen Holders

FR: Porte-stylo magnétique  
 ES: Soporte magnético de bolígrafo  
 DE: Magnetischer Stifthalter

10  
PACK

Keep your detectable markers safely attached to your whiteboard or clipboard with these magnetic pen holders.



\*Pen not included

### Features & Options

- Metal detectable
- X-Ray visible
- Zinc plated

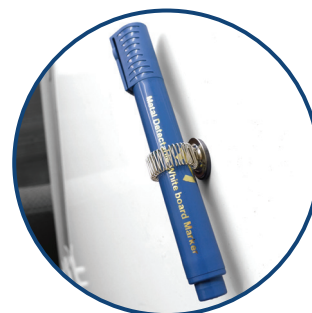

**PRODUCT CODE:** 308-T189

More product codes available – please contact us for a full price list

## Metal Detectable Mechanical Pencils

FR: Crayon mécanique  
 ES: Lápiz mecánico  
 DE: Druckbleistift

10  
PACK

These mechanical pencils are blue metal, allowing for visual detection, with the clip, nib and end being made from magnetic metal. This makes them perfect for food processing environments.

### Features & Options

- Metal detectable
- Refill available

**Refillable**

### End type:

- Clip



**Housing Colour:**

**PRODUCT CODE:** 131-C100

## Metal Detectable & X-Ray Visible Pen Grip

FR: Manchon pour stylo Detectagrip  
 ES: Funda para bolígrafos Detectagrip  
 DE: Detectagrip ergonomischer Stifthalter

1  
PACK  
of 40mm

1  
PACK  
of 1m

Perfect for wet and greasy environments, this detectable easy grip pen sleeve allows a tight grip and can be either bought in "pen" lengths or in 1m for you to cut to your own size.

**Made In:**  
 UK



\*Pen not included

### Features & Options

- Metal detectable
- X-Ray visible



**Colour:**

**PRODUCT CODE:** 123-P01

# Metal & X-Ray Detectable Swipe / Access Card Holders

FR: Support pour carte magnétique

ES: Funda para tarjetas magnéticas

DE: Magnetkartenhalter



Control access to key sensitive and high-risk areas by securing swipe cards in these metal detectable swipe card holders.

## Features & Options

**25  
PACK**

In Partnership with  
**BRCS**

**30**

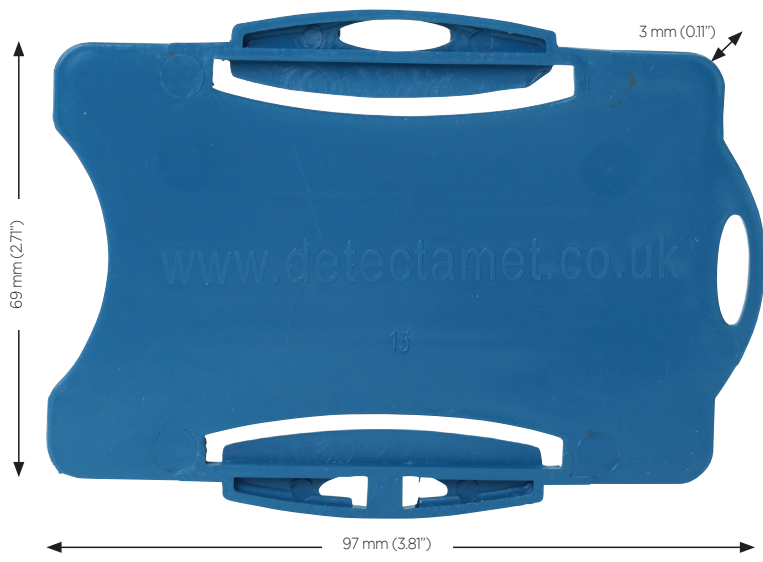

### TWO LANYARD ATTACHMENT POINTS

allowing swipe cards to be held horizontally or vertically



### AVAILABLE IN 9 DIFFERENT COLOURS

to help with your cross-contamination prevention plan and easily identify people in the wrong areas.



**SUITABLE FOR PAD PRINTING/LASER ENGRAVING**

**DURABLE**

### AVAILABLE WITH SAFETY CHAIN

(additional charge applicable)



**CARD HOLDER CLIPS TO OUR DETECTABLE BADGE REEL**



**detectamet**

**PRODUCT CODE: 212-A65-A5**



# Fully Metal Detectable Lanyard

FR: Cordon

ES: Acollador

DE: Lanyard



Fully metal detectable silicone lanyard. Perfect for hanging items around the neck thanks to the split ring and clip. The intelligent detectable break-away clasp allows the user to reattach their detectable lanyard if it were to break apart.

## Features & Options



SUPPLIED WITH SPLIT RING & CLIP

FEATURES METAL DETECTABLE & X-RAY VISIBLE SAFETY BREAK-AWAY CLASP



### Features & Options

- Metal Detectable
- Blue, Black, Red, Green & Grey Available
- Size: 480 mm (19.68") length



**PRODUCT CODE: 154D**

In Partnership with  
**BROS**

31

**Detectamet**

# Fully Metal Detectable Wrist Straps

FR: Dragonne

ES: Correa para la muñeca

DE: Trageschlaufe



Fully metal detectable wrist strap. Perfect for securing items to your wrist thanks to the split ring and clip.

## Features & Options



SUPPLIED WITH SPLIT RING & CLIP

FEATURES METAL DETECTABLE & X-RAY VISIBLE SAFETY BREAK-AWAY CLASP

SECURING ITEMS AROUND THE USER'S WRIST MINIMISES THE RISK OF ITEMS BEING DROPPED



### Features & Options

- Metal Detectable
- Blue, Black, Red, Green & Grey Available
- Size: 110 mm (4.33") length

Colour:

PRODUCT CODE: 154D

## Metal Detectable & X-Ray Visible Desktop Calculator

**FR:** Calculatrice de bureau avec touches détectables  
**ES:** Calculadora de escritorio con botones detectables  
**DE:** Tischrechner mit erfassbaren Tasten

This large desktop calculator is fully detectable, including buttons, and can be easily used with gloved hands.

1  
PACK



### Features & Options

- Metal detectable
- X-Ray visible
- Automatic power off
- Suitable for pad printing/laser engraving
- Size: 150 x 120 mm (5.90 x 4.72")

Colour:

**PRODUCT CODE:** 202F-P01

More product codes available – please contact us for a full price list

## Metal Detectable & X-Ray Visible Handheld Calculator

**FR:** Support pour calculatrice  
**ES:** Portacalculadoras  
**DE:** Halter für Taschenrechner

This lightweight, compact calculator is fully detectable, including buttons, and can also be ordered with a chain and ring so you can attach to a clipboard.

1  
PACK



### Features & Options

- Metal detectable
- X-Ray visible
- Automatic power off
- Suitable for pad printing/laser engraving
- Option with chain and ring (additional charge applicable)
- Size: 113 x 64 mm (4.44 x 2.51")



Colour:

**PRODUCT CODE:** 202S-P01

## Metal Detectable & X-Ray Visible Calculator Holder

**FR:** Calculatrice de bureau avec touches détectables

**ES:** Calculadora de escritorio con botones detectables  
**DE:** Tischrechner mit erfassbaren Tasten

Keep your calculator safe and secure with this wall mountable calculator holder. Available in two sizes, to store both desktop and handheld calculators.

1  
PACK

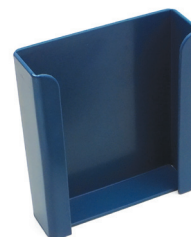

### Features & Options

- Metal detectable
- X-Ray visible
- Wall mountable or with magnetic strips to attach to whiteboards etc.
- Suitable for pad printing/laser engraving
- 2 sizes to fit handheld or desktop calculator



**Made In:**  
 UK   
 USA 

Colours:

**PRODUCT CODE:** 200D-P0

In Partnership with  
**BROGS**

33

**detectamet**

## Metal Detectable & X-Ray Visible Phone & Tablet Cases

FR: Etui pour téléphone et tablette  
 ES: Funda para teléfono y tableta  
 DE: Telefon- und Tablet-Hülle

Metal detectable & X-ray visible smartphone or tablet case. Suitable for keeping your devices protected in a manufacturing environment.

We can customise this product to suit your specific tablet or phone, so once your order is placed we'll reach out to you to discuss your requirements.

**SIZE:**

Product manufactured to custom size upon receipt of order.

Colours:

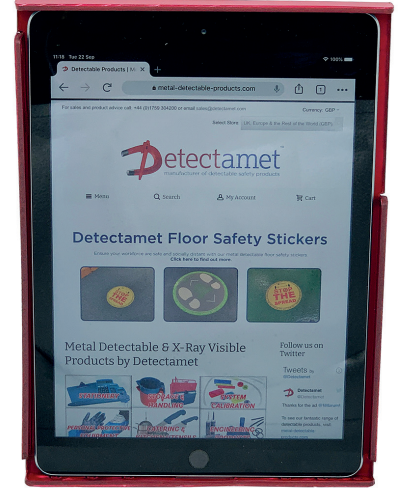

In Partnership with  
**BRCGS**

**PRODUCT CODE:** 135-T597 (Phone Case) & 135-T598 (Tablet Case)

Sequential numbering available for all products • Ask us for a pen and knife guide

34

## Metal Detectable & X-Ray Visible Food Temperature Probe

FR: Sonde de température pour aliments  
 ES: Sonda de temperatura para alimentos  
 DE: Temperaturfühler für Lebensmittel

With a patent pending, this fully detectable food temperature probe is available in blue or red, and has a wide measuring range and high accuracy levels.

1  
PACK



**PATENTED PRODUCT!**

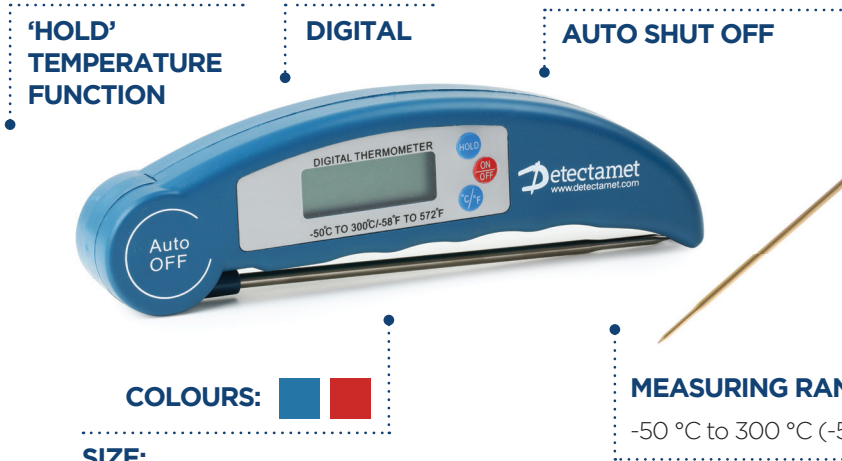

COLOURS:

**SIZE:**

155 x 45 mm (6.10 x 1.77")  
 Probe length 112 mm (4.40")

**MEASURING RANGE:**

-50 °C to 300 °C (-58 °F to 572 °F)

**ACCURACY:**

+/- 1 degree between -20 °C to 200 °C  
 (+/- 2 degrees for other temperatures)

**PRODUCT CODE:** 110-P01 (blue), 110-P03 (red)

**Detectamet**



## Metal Detectable Timer

FR: Minuteurs

ES: Temporizadores

DE: Zeitschaltuhren

A fully detectable timer, complete with magnet and fold out stand.

### Features & Options

1  
PACK



PERFORMS WELL IN FOOD RELATED ATMOSPHERIC CONDITIONS

MAGNET FOR ATTACHING TO MACHINE



SUITABLE FOR PAD PRINTING/LASER ENGRAVING

FOLD OUT STAND

Colour:

PRODUCT CODE: 215-P01

More product codes available – please contact us for a full price list

## Metal Detectable & X-Ray Visible Food Temperature Probe Holder

FR: Support de sonde de température pour aliments

ES: Soporte de sonda para alimentos

DE: Halterung für Lebensmittel-Temperaturfühler

This ergonomic, wall mountable, detectable temperature probe holder is available in either portrait or landscape orientation and a wide range of colours.

1  
PACK

Made In:  
UK USA



NEW 2021  
INTERLOCKING  
DESIGN

### Features & Options

- Metal detectable
- X-Ray visible
- Ergonomic and easy to use
- Wall mountable with pre-drilled hole for easy assembly
- Orientation: horizontal and vertical

Colours:

PRODUCT CODE: 110H-O34-P0

## Metal Detectable & X-Ray Visible Stopwatch

FR: Chronomètre

ES: Cronómetro

DE: Stoppuhr

A fully detectable stopwatch, complete with neck chain.

1  
PACK



### Features & Options

- Metal detectable
- X-Ray visible
- Performs well in most food related atmospheric conditions
- Suitable for pad printing/laser engraving
- Also available with lanyard or no chain

Colour:

PRODUCT CODE: 201-A65

In Partnership with  
**BROGS**

35

**Detectamet**

# Metal & X-Ray Detectable Scissors

FR: Ciseaux ou ciseaux de sécurité  
ES: Tijeras o tijeras de seguridad  
DE: Scheren oder Sicherheitsscheren

**Best Seller!**

These general purpose scissors have blades manufactured from stainless steel, have detectable handles and are also available with safety blades.

## Features & Options

**1**  
PACK



SUITABLE FOR LASER ENGRAVING MAKING IDEAL FOR SEQUENTIAL NUMBERING

Safety Blades

AVAILABLE WITH STANDARD OR SAFETY BLADES



Colour:

**PRODUCT CODES:** 206-S237-P01-Q01 (standard), 219-P01-S237-Q03 (safety)

In Partnership with  
**BRCS**

36

**Detectamet**

## Metal Detectable & X-Ray Visible Scissor Holders

FR: Support pour ciseaux

ES: Portatijeras

DE: Scherenhalter

These detectable scissor holders keep your scissors safe when not in use and have a drainage slot at the base, making it easy to clean.

### Features & Options

- Metal detectable
- X-Ray visible
- Wall mountable or with integrated hanging hook
- Suitable for pad printing/laser engraving

5  
PACK



Made In:  
UK   
USA 

Colours: 

PRODUCT CODE: 218-PO

More product codes available – please contact us for a full price list

## Metal Detectable & X-Ray Visible Mouse Mat

FR: Tapis de souris

ES: Almohadilla para ratón

DE: Mauspad

This mouse mat is manufactured from food safe detectable material.

1  
PACK



Made In:  
UK   
USA 

Colour: 

PRODUCT CODE: 203-A65-P01-S232

In Partnership  
with  
**BREGS**

37

**Detectamet**



# Metal Detectable Utility Pouch

FR: Pochette utilitaire

ES: Estuche de herramientas

DE: Gebrauchstasche



Our fully metal detectable utility pouches are the perfect storage solution for a great variety of our detectable products. Made from our flexible detectable silicone, these pouches can comfortably store safety knives, stationery, safety glasses and face coverings.

## Features & Options

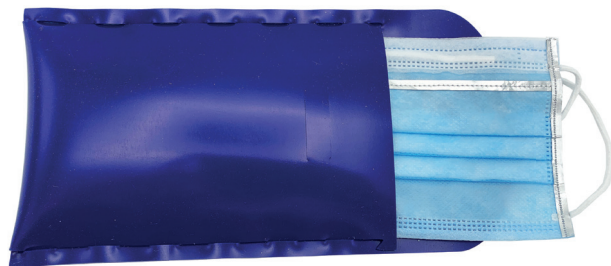
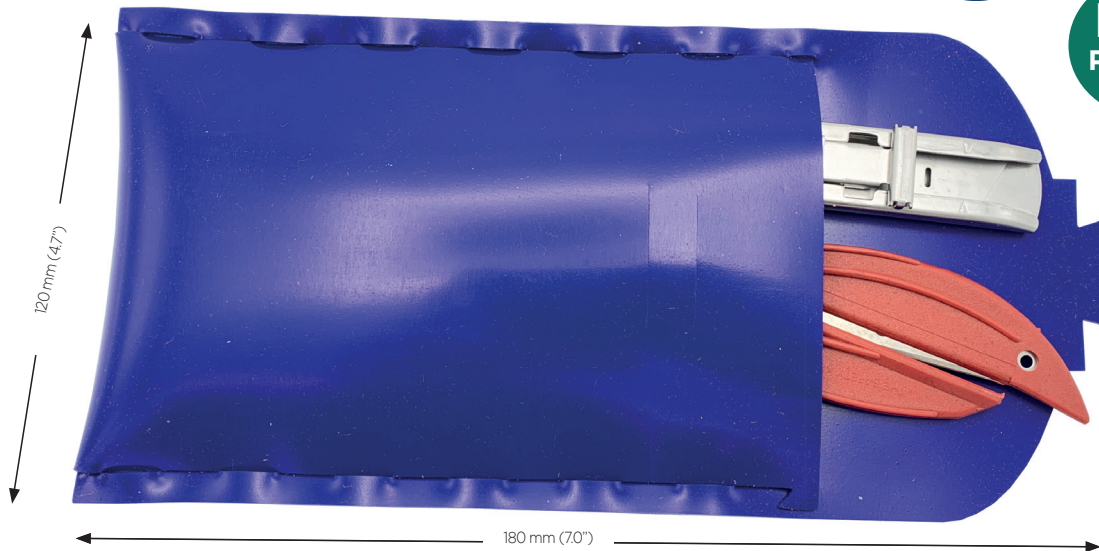

PERFECT FOR A GREAT VARIETY OF PPE, STATIONERY & HANDLING EQUIPMENT

PLEASE GET IN TOUCH IF YOU REQUIRE THIS PRODUCT TO BE FITTED TO A LANYARD CLIP

Colour:

PRODUCT CODES: 809-1240

In Partnership with  
**BRCS**

38

etectamet

## Metal Detectable & X-Ray Visible Tape Measure

FR: Mètre ruban  
 ES: Cinta métrica  
 DE: Maßband

1  
PACK

A heavy duty 5m (16') tape measure manufactured from Detectamet's detectable polymer.



### Features & Options

- Metal detectable
- X-Ray visible
- Metric and imperial scales
- Length 5m (16')
- Tape width 19 mm (0.74")
- Suitable for pad printing/laser engraving

Colour:

**PRODUCT CODE:** 468-S575-P64

## Metal Detectable & X-Ray Visible Plastic Rulers

FR: Règles en plastique  
 ES: Reglas de plástico  
 DE: Plastiklineale

5  
PACK

These rulers are manufactured from our detectable polymer, have both metric and imperial measurements and are available in two standard lengths.

### Features & Options

- Metal detectable
- X-Ray visible
- Lengths: 150 mm (5.90") and 300 mm (11.81")
- Suitable for pad printing/laser engraving

Colour:

Made In:  
 UK

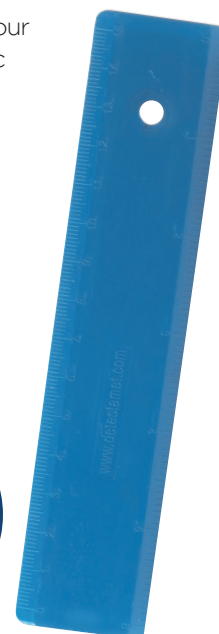

**PRODUCT CODE:** 204-P01

## Metal Detectable & X-Ray Visible Stainless Steel Ruler

FR: Règles en acier inoxydable  
 ES: Reglas de acero inoxidable  
 DE: Lineale aus Edelstahl

1  
PACK

A 304 Stainless steel ruler in three sizes, showing both metric and imperial measurements. Also available in an assorted pack of three sizes.

### Features & Options

- Metal detectable
- X-Ray visible
- Lengths: 150 mm (6"), 300 mm (12") and 450 mm (18")

Colour:

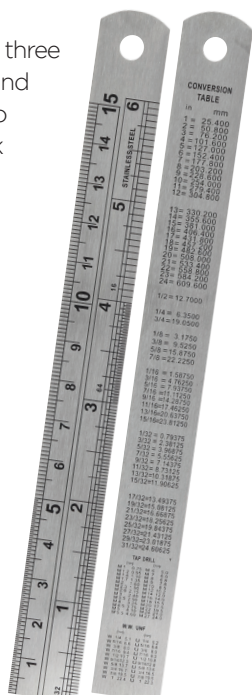

**PRODUCT CODE:** 208-P32

## Metal Detectable & X-Ray Visible Retractable Badge Reels

FR: Enrouleur de badge rétractable  
 ES: Carrete retráctil para insignia  
 DE: Ausweishalter mit Aufroller

4  
PACK

Retractable badge reels designed to keep ID cards / keys secure and always in the correct place.



### Features & Options

- Metal detectable
- X-Ray visible
- Detectable cord length: 700 mm (27.55")
- Suitable for laser engraving
- Hanging clip on reverse to easily attach to clothing

Colour:

**PRODUCT CODE:** 217-A65

In Partnership with  
**BROGS**

39

**Detectamet**



## Metal Detectable & X-Ray Visible Stainless Steel Safety Chains & Split Rings

10  
PACK

**FR:** Anneau brisé ou chaîne de sécurité  
**ES:** Cadena de seguridad o con anillo partido  
**DE:** Spaltring- oder Sicherheitskette

These 304 stainless steel safety chains are 762mm (30.00") in length, with safety feature designed to break if caught in a machine. The split rings are 20mm (0.78") in diameter, suitable for use with all Detectamet products which come with a clip.



### Features & Options

- Metal detectable
- X-Ray visible
- Split rings and safety chains must be bought separately

**Colour:**

**PRODUCT CODE:** 155-P44-S083-A93/153-T203

## Metal Detectable & X-Ray Visible Plastic Paper Clips

30  
PACK

**FR:** Trombones en plastique  
**ES:** Sujetapapeles de plástico  
**DE:** Büroklammern aus kunststoff

Made from Detectamet's unique metal detectable and X-Ray visible polymer, these paper clips are available in nine highly visible colours and eliminate the need for staples in food processing environments. Also suitable for use as economy ear savers.



Made In:  
UK

### Features & Options

- Metal detectable
- X-Ray visible
- Durable
- Easy to clean
- Holds up to 80 sheets of 80gm paper
- Size: 80 x 40 mm (3.14 x 1.57")

**Colours:**

**PRODUCT CODE:** 210-S243

Sequential numbering available for all products • Ask us for a pen and knife guide

## Non-Detectable 7 Sheet Staple-Free Stapler

**FR:** Agrafeuse sans agrafes  
**ES:** Engrapadora sin grapas  
**DE:** Heftgerät ohne klammern

A non-detectable staple-free stapler that securely fixes 7 sheets of paper without the need for a staple.

NO NEED  
FOR STAPLES

### Features & Options

1  
PACK

SECURELY FIXES  
7 SHEETS OF  
PAPER



### SIZE:

W30 x D135 x H70 mm  
(1.18 x 5.31 x 2.75")



**Colours:**

**PRODUCT CODE:** 207-A66-T145

## Non-Detectable 10 Sheet Staple-Free Stapler

FR: Agrafeuses sans agrafes non détectables

ES: Engrapadora sin grapas no detectable

DE: Heftgerät ohne Klammern, nicht erfassbar

This non-detectable staple-free stapler securely fixes 10 sheets of paper without the need for a staple.

### Features & Options



#### SIZE:

W70 x D130 x H110 mm  
(2 3/4 x 5 1/8 x 4 5/16")

**SECURELY FIXES 10 SHEETS OF PAPER**

Colours:



**NO NEED FOR STAPLES**

**PRODUCT CODE:** 207-A66-T301

More product codes available – please contact us for a full price list

## Non-Detectable 5 Sheet Staple-Free Crimper

FR: Sertisseuse sans agrafes

ES: Punzonadora sin grapas

DE: Heftzange ohne klammern

This non-detectable staple-free crimper securely fixes 5 sheets of paper together without the need for a staple.

### Features & Options



**SECURELY CRIMPS TOGETHER 5 SHEETS OF PAPER**

#### SIZE:

W34 x D95 x H85 mm  
(1.33 x 3.74 x 3.34")

Colour:

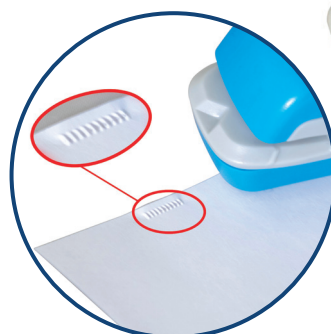

**NO NEED FOR STAPLES**



**PRODUCT CODE:** 207-A66-T302-P01

## Metal Detectable & X-Ray Visible 5 Sheet Staple-Free Staplers

FR: Agrafeuse sans agrafes

ES: Engrapadora sin grapas

DE: Heftgerät ohne Klammern

**MANUFACTURED FROM  
EU AND FDA FOOD  
CONTACT APPROVED  
DETECTABLE POLYMER**

These staple free staplers are made from our detectable polymer and securely fasten up to 5 sheets by a unique cut, fold and fix technique.



### Features & Options

**5  
PACK**

Colour: 

**SECURELY FIXES  
UP TO 5 SHEETS**



**SIZE:**

60 x 44 mm  
(2.36 x 1.73")

**PRODUCT CODE:** 207-A65-T184-P01

Sequential numbering available for all products • Ask us for a pen and knife guide

## Metal Detectable Paper

FR: Papier détectable métallique

ES: Papel metálico detectable

DE: Metalldetektierbares Papier

This metal detectable paper is tear, water, oil, grease and weather resistant, making it perfect for the food production environment, and available in packs of 25, 50 and 100 sheets.

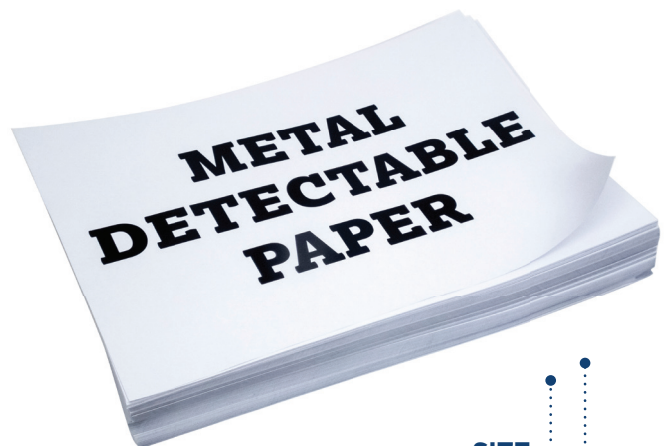

### Features & Options

**25  
PACK**

**50  
PACK**

**100  
PACK**

**Made In:**  
**USA** 

**SIZE:**

A4 210 x 297 mm  
(8.26 x 11.69")

Letter 216 x 297mm  
(8.50 x 297")

**CONSULT YOUR  
PRINTER'S MANUAL  
BEFORE USING**

**BESPOKE SIZES  
AVAILABLE**

Colours:

 (Colours other than white subject to MOQ)

**PRODUCT CODE:** 251-S04

# Detectamet Offer **Own Branding & Sequential Numbering**

**Perfect for knives and other products, sequential numbering is done in-house on our laser engraving machine.**

Sequential numbering gives you complete traceability and is particularly important if production presents higher risks, making it even more important to eliminate any type of contamination.

Our cost effective laser engraving service adds sequential numbers onto your products.

**How about branding your detectable products using our cost effective pad printer?**

Pad printing offers superior quality one and two colour print on 3D irregular, curved and textured objects, making it perfect for our products.

**Where pad printing and laser engraving are not appropriate - due to the product - we can print your logos at point of manufacture, e.g. keyhole tags, test pieces. Ask a member of our team for advice.**

**Can't see what you're looking for?**

**Or are you looking for a detectable product for a specific project or application?**

**Don't worry!** We're always happy to talk about bespoke products and will always try our best to find a solution.





# Metal & X-Ray Detectable Clipboards



Our range of clipboards can be tailored to meet your individual needs. Talk to a sales representative for more details and product codes.

## Features & Options

In Partnership with  
**BRCS**

44

### MATERIAL OPTIONS

- Aluminium
- Stainless Steel
- Plastic Polymer with metal detectable additive
- Plastic Polymer with metal detectable additive and magnetic strip

### CLIP TYPE

- Heavy Duty Stainless Steel
- Stainless Steel & Chrome
- Economy Clip
- Jumbo Chrome Plated Clip
- Stainless Steel Bulldog
- Serrated Edge
- Zinc Plated with Pen Holder

### ORIENTATION

- Landscape
- Portrait

### BRANDING

- Suitable for laser engraving

### CLIPBOARD COLOURS

- Blue, black, red, green, yellow, white, purple, orange, pink, silver

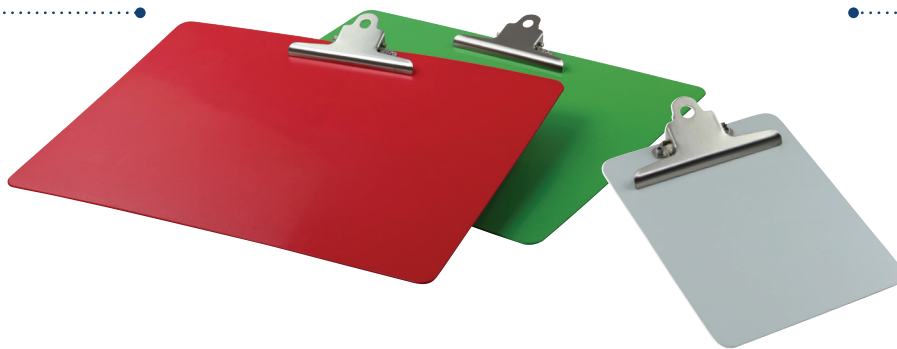

### THESE CLIPBOARDS ARE DESIGNED TO SUIT STANDARD SIZED PAPER

- A3 size 297 x 420 mm (11.69 x 16.53")
- A4 size 210 x 297 mm (8.26 x 11.69")
- A5 size 148 x 210 mm (5.82 x 210")

### HANGING OPTION

- Rolled hanging hook option suitable for bars up to 45mm (1 3/4") diameter
- Folded hanging hook option suitable for bars up to 30mm (1 3/16") diameter

### ACTUAL CLIPBOARD SIZES

- A3 350 x 460 mm (13.77 x 18.11")
- A4 230 x 320 mm (9.05 x 12.59")
- A5 180 x 230 mm (7.08 x 9.05")

### CLIP COLOUR

- Silver
- Blue, green, red, yellow (only available in Heavy Duty Stainless Steel and Stainless Steel & Chrome clips)
- Black (only available in Stainless Steel Bulldog clip)

etectamet



# Clipboard Options

## MATERIAL OPTIONS

Aluminium  
Stainless Steel  
Metal detectable & X-Ray visible plastic



Colours:



## TO FIT PAPER SIZES

A3 size 297 x 420 mm (11.69 x 16.53")  
A4 size 210 x 297 mm (8.26 x 11.69")  
A5 size 148 x 210 mm (5.82 x 8.26")

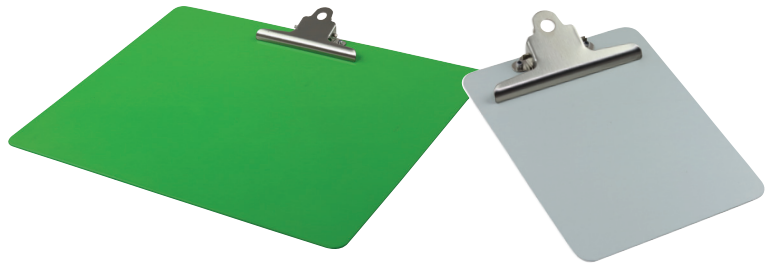

## ORIENTATION

Landscape  
Portrait

## CLIPBOARD CLIP OPTIONS



## LASER MARKING

custom printing



## HANGING OPTIONS

Stainless/steel and aluminium available with rolled or folded hanging hooks. Plastic boards available with stainless steel hanging hook

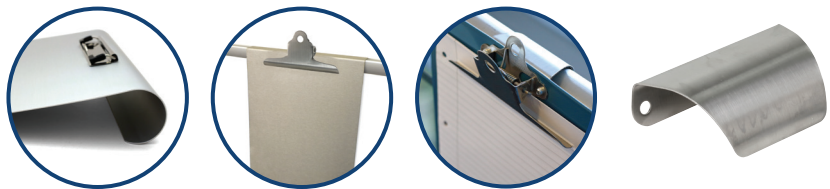

## MULTIPLE CLIPS/BESPOKE BOARDS

Whatever your requirement for a board, we can make it for you



# Design Your Own Detectamet Clipboard



## Step 1 - Board material

- ALUMINIUM
- STAINLESS STEEL
- DETECTABLE PLASTIC

## Step 2 - Board colour

- BLUE
- BLACK
- RED
- GREEN
- YELLOW
- WHITE
- PURPLE
- ORANGE
- PINK
- SILVER

\*Colours only available in detectable plastic

## Step 3 - Board size

- A3 SIZE**  
350 x 460mm  
(13 3/4 x 18 1/8")
- A4 SIZE**  
230 x 320mm  
(9 1/16 x 12 5/8")
- A5 SIZE**  
180 x 230mm  
(7 1/16 x 9 1/16")

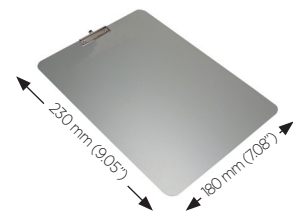
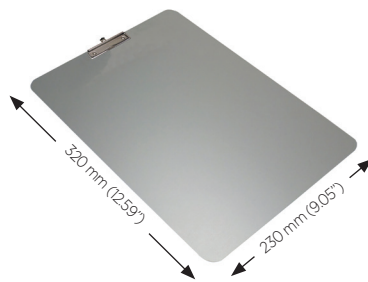
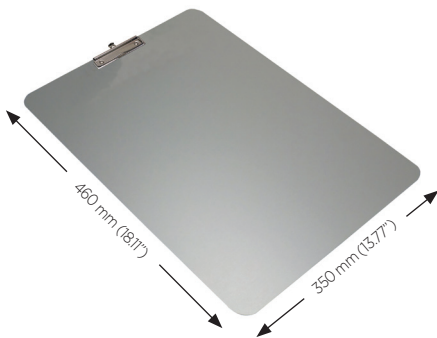

## Step 4 - Portrait or landscape

- PORTRAIT
- LANDSCAPE



## Step 5 - Clip or ring binder mechanism type

STAINLESS STEEL ECONOMY CLIP



CHROME ECONOMY CLIP



STAINLESS STEEL HEAVY DUTY CLIP



JUMBO CHROME PLATED CLIP

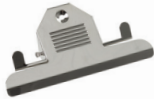

CHROME SERRATED EDGE CLIP



ZINC PLATED CLIP WITH PEN HOLDER



*\*Pen not included*

RING BINDER MECHANISM - 2 rings inner dia. 30 mm (1.18")



RING BINDER MECHANISM - 2 rings inner dia. 43 mm (1.69")



RING BINDER MECHANISM - 3 rings inner dia. 30 mm (1.18")



RING BINDER MECHANISM - 3 rings inner dia. 43 mm (1.69")



RING BINDER MECHANISM - 4 rings inner dia. 43 mm (1.69")



## Step 6 - No. of clips or ring binder mechanisms

1 CLIP

1 BINDER MECHANISM

2 CLIPS

2 BINDER MECHANISMS

3 CLIPS

3 BINDER MECHANISMS



## Step 7 - Pad print or laser engrave your board

LASER ENGRAVE

PAD PRINT



# Metal & X-Ray Detectable Aluminium or Stainless Steel Clipboard

**FR:** Tablettes en aluminium anodisé ou en acier inoxydable  
**ES:** Tablas sujetapapeles de aluminio anodizado o acero inoxidable  
**DE:** Klemmbretter aus eloxiertem aluminium oder Edelstahl



This clipboard is available in either rolled aluminium or 304 stainless steel to fit A3, A4 and A5 sized paper, flat or folded, in either portrait or landscape. The Aluminium clipboard is anodised to avoid rust and corrosion, making it suitable for use in food processing environments.

## Features & Options



SUITABLE FOR LASER ENGRAVING

### A3 SIZE

350 x 460 mm  
(13.77 x 18.11")

### A4 SIZE

230 x 320 mm  
(9.05 x 12.59")

### A5 SIZE

180 x 230 mm  
(7.09 x 9.05")

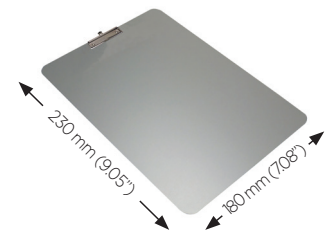
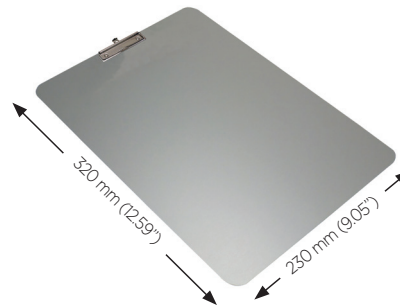
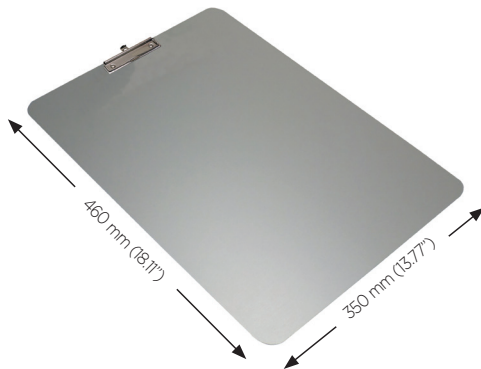

PORTRAIT OR LANDSCAPE



ROLLED OR FOLDED OPTION FOR HANGING



Colour:

PRODUCT CODE: 300

# Metal & X-Ray Detectable Plastic Clipboard

FR: Tablette en plastique entièrement détectable

ES: Tabla sujetapapeles de plástico completamente detectable

DE: Vollständig detektierbares Klemmbrett aus Plastik

This fully detectable plastic clipboard is available in wide range of colours to fit A3, A4 and A5 sized paper, flat or folded, in either portrait or landscape.



## Features & Options

SUITABLE FOR  
LASER ENGRAVING

### A3 SIZE

350 x 460 mm  
(13.77 x 18.11")

### A4 SIZE

230 x 320 mm  
(9.05 x 12.59")

### A5 SIZE

180 x 230 mm  
(7.08 x 9.05")

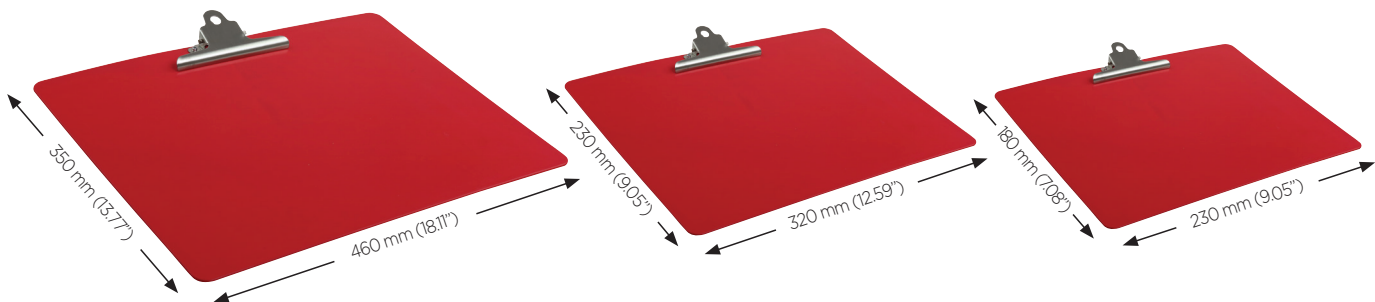

PORTRAIT OR  
LANDSCAPE

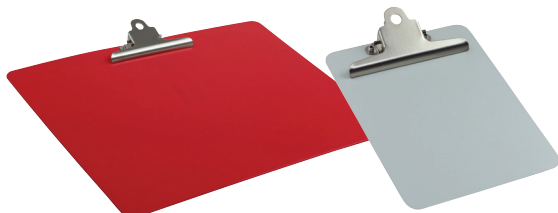

ROLLED OR FOLDED  
OPTION FOR HANGING



Colours:

PRODUCT CODE: 300



## Metal Detectable & X-Ray Visible Stainless Steel Hanging Hooks

FR: Crochets de suspension pour pinces robustes en acier inoxydable

ES: Ganchos para colgar para sujetapapeles de acero inoxidable de alta resistencia

DE: Aufhängehaken für extrastarke Edelstahlklammern

Attach these stainless steel hanging hooks onto the reverse of clipboards and hang over a door/whiteboard etc. to keep it where it's most needed.

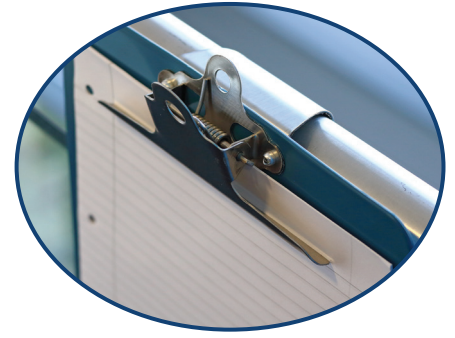

**ONLY SUITABLE FOR USE WITH HD CLIP OR ON ITS OWN**

### Features & Options

**5**  
PACK

**GAP BETWEEN CLIPBOARD HOLES 68MM (2.6")**

**HOLE SIZE 5MM (0.19")**

Colour: 

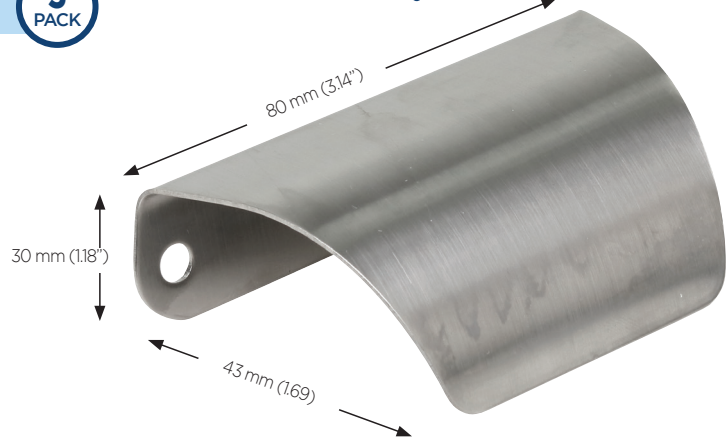

**PRODUCT CODE:** 310-T204

Sequential numbering available for all products • Ask us for a pen and knife guide

## Metal Detectable & X-Ray Visible Stainless Steel & Chrome Economy Clipboard Clips

FR: Pincas économiques en acier inoxydable

ES: Sujetapapeles económicos de acero inoxidable

DE: Edelstahlklammern

Economy stainless steel & chrome clipboard clips are suitable for mounting onto a range of detectable clipboards. Also available with a powder coated finish.



**WITH HANGING HOOK**

### SIZES:

120 x 30 mm (4.72 x 1.18"),  
100 x 30 mm (3.93 x 1.18")  
(chrome, plain finish only)

**SUITABLE FOR LASER ENGRAVING**

### Features & Options

**5**  
PACK

**HOLDS APPROXIMATELY 50 SHEETS OF PAPER**

**GAP BETWEEN CLIPBOARD HOLES 74 MM (2.9")**  
**CLIPBOARD HOLE SIZE 5 MM (0.19")**

**GAP BETWEEN CLIPBOARD HOLES 87 MM (3.4")**  
**CLIPBOARD HOLE SIZE 5 MM (0.19")**

Colours:     

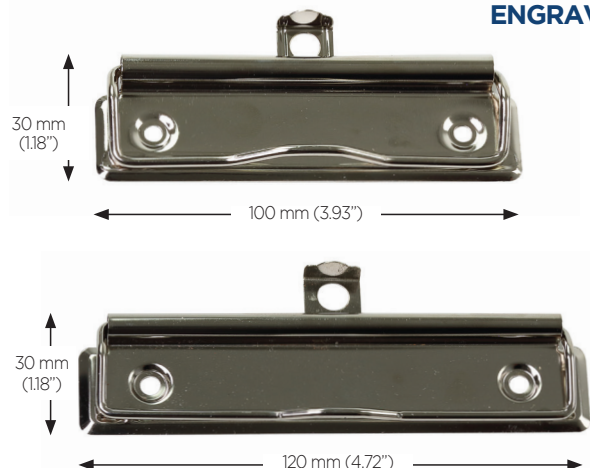

**PRODUCT CODE:** 307-T

## Metal Detectable & X-Ray Visible Heavy Duty Stainless Steel Clipboard Clips

FR: Pincas robustes en acier inoxydable

ES: Sujetapapeles de acero inoxidable de alta resistencia

DE: Extrastarke Edelstahlklammern

Heavy duty 100% stainless steel clips for your own use. Suitable for mounting onto a range of detectable clipboards they are available in silver or with a powder coated finish.

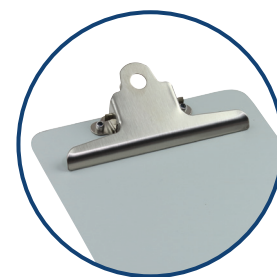

### Features & Options

**5**  
PACK

**HOLDS APPROXIMATELY 100 SHEETS OF PAPER**

**SUITABLE FOR LASER ENGRAVING**

68 mm (2.67")  
**GAP BETWEEN CLIPBOARD HOLES**  
**68 MM (2.6")**  
**CLIPBOARD HOLE SIZE 5 MM (0.19")**

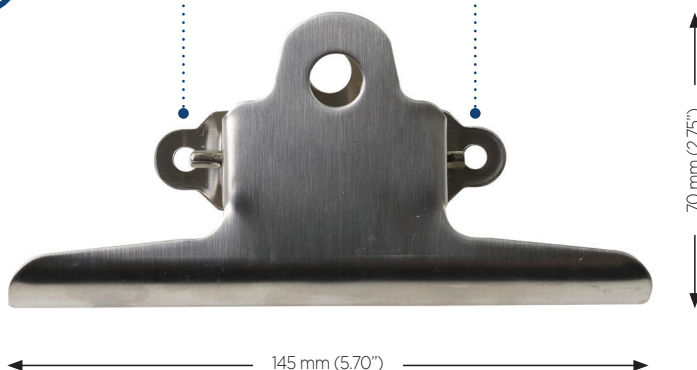

Colours:

**PRODUCT CODE:** 307-T185

Sequential numbering available for all products • Ask us for a pen and knife guide

## Metal Detectable & X-Ray Visible Jumbo Chrome Plated Clips

FR: Pincas chromées jumbo

ES: Sujetapapeles cromados Jumbo

DE: Verchromte Riesenklammern

Jumbo chrome plated clipboard clips, suitable for mounting onto a range of detectable clipboards.

### Features & Options

**5**  
PACK

**HOLDS APPROXIMATELY 150 SHEETS OF PAPER**

74 mm (2.91")  
**GAP BETWEEN CLIPBOARD HOLES**  
**74 MM (2.9")**  
**CLIPBOARD HOLE SIZE 5 MM (0.19")**

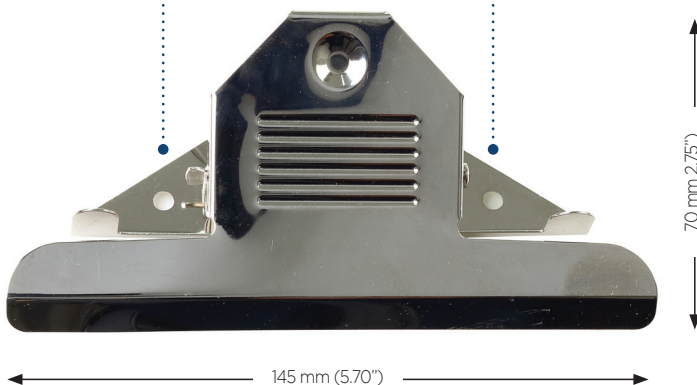

Colour:

**PRODUCT CODE:** 307-T232

## Metal Detectable & X-Ray Visible Stainless Steel Bag Clips

FR: Clips de sac  
 ES: Clips de bolsa  
 DE: Taschendlips

Manufactured from stainless steel, including springs, these bag clips are available in 2 sizes.



**New Products!**

**Features & Options** 5 PACK

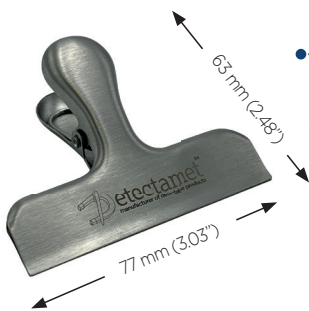

**HOLDS APPROXIMATELY 100 SHEETS OF PAPER**



**HOLDS APPROXIMATELY 180 SHEETS OF PAPER**

In Partnership with  
**BROS**

**PRODUCT CODE:** 309-S997 (Small) & 309-S998 (Large)

Sequential numbering available for all products • Ask us for a pen and knife guide

**52**

## Metal Detectable & X-Ray Visible Stainless Steel Bulldog Clips

FR: Clips de sac  
 ES: Clips de bolsa  
 DE: Taschendlips

**SUITABLE FOR LASER ENGRAVING**



**HOLDS APPROXIMATELY 180 SHEETS OF PAPER**

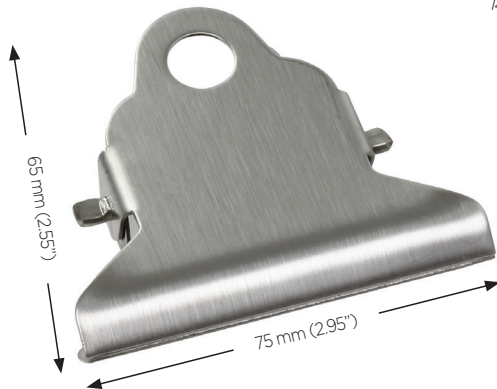

**HOLDS APPROXIMATELY 100 SHEETS OF PAPER**



**HOLDS APPROXIMATELY 50 SHEETS OF PAPER**

**SUITABLE FOR POWDER COATING**

Colour:

**PRODUCT CODE:** 309-S392, 309-S393

**etectamet**

## Metal Detectable & X-Ray Visible Chrome Serrated Edge Clips

FR: Pincas économiques crantées galvanisées  
 ES: Sujetapapeles dentados económicos cincados  
 DE: Verzinkte Klammern mit Kammprofil

**5**  
PACK

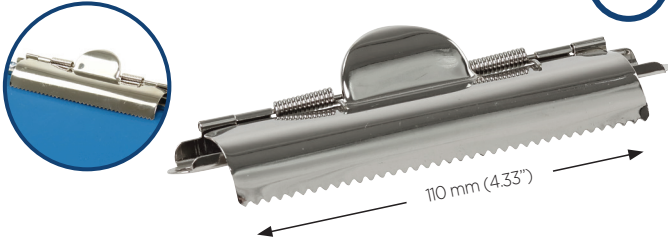

**SUITABLE FOR LASER ENGRAVING**

**GAP BETWEEN CLIPBOARD HOLES 102 MM (4")**  
**CLIPBOARD HOLE SIZE 4 MM (0.15")**

**HOLDS APPROXIMATELY 50 SHEETS OF PAPER**

**SIZE:**  
110 mm (4.33")

Colour:

**PRODUCT CODE:** 313-S631-P42

## Metal Detectable & X-Ray Visible Zinc Plated Clips with Pen Holders

FR: Pince galvanisée économique avec support pour stylo  
 ES: Sujetapapeles cincado económico con portabolígrafo  
 DE: Verzinkte Klemmen mit Stiftehalter

**5**  
PACK

Zinc plated clipboard clips with pen holders, suitable for mounting onto a range of detectable clipboards.



**SIZE:**  
120 x 30 mm  
(4.72 x 1.18")

**INCLUDES PEN HOLDER**

**SUITABLE FOR LASER ENGRAVING**

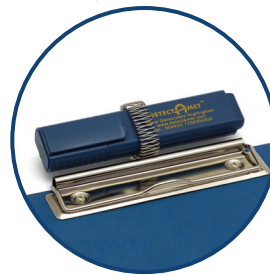

**HOLDS APPROXIMATELY 50 SHEETS OF PAPER**

Colour:

**PRODUCT CODE:** 307-T188

More product codes available – please contact us for a full price list

## Metal Detectable & X-Ray Visible Stainless Steel Jaw Clips

FR: Clips de mâchoire  
 ES: Pinzas de mandíbula  
 DE: Backenclips

Manufactured from stainless steel, including springs, these jaw clips are available in two sizes, both featuring serrated edges on the inside of the 'jaw' clasp for added security.

**Features & Options**

**5**  
PACK



**SUITABLE FOR LASER ENGRAVING**



Colour:

**PRODUCT CODE:** 309-S995-P45 (79 mm) , 309-S996-P45 (115 mm)

In Partnership with  
**BREGS**

**53**

**Detectamet**  
 manufacturer of detectable products



# Metal & X-Ray Detectable Magnetic Clipboard

FR: Tablettes magnétiques détectables

ES: Tablas sujetapapeles magnéticas detectables

DE: Detektierbare magnetische Klemmbretter



This magnetic clipboard is available in a wide range of colours and sizes, with a very strong magnet that sticks to most ferrous surfaces e.g. whiteboards, machines, metal partitions etc.

## Features & Options



PLEASE ASK US ABOUT BESPOKE SIZES

SUITABLE FOR LASER ENGRAVING

### A3 SIZE

350 x 460 mm  
(13.77 x 18.11")

### A4 SIZE

230 x 320 mm  
(9.05 x 12.59")

### A5 SIZE

180 x 230 mm  
(7.08 x 9 1/16")

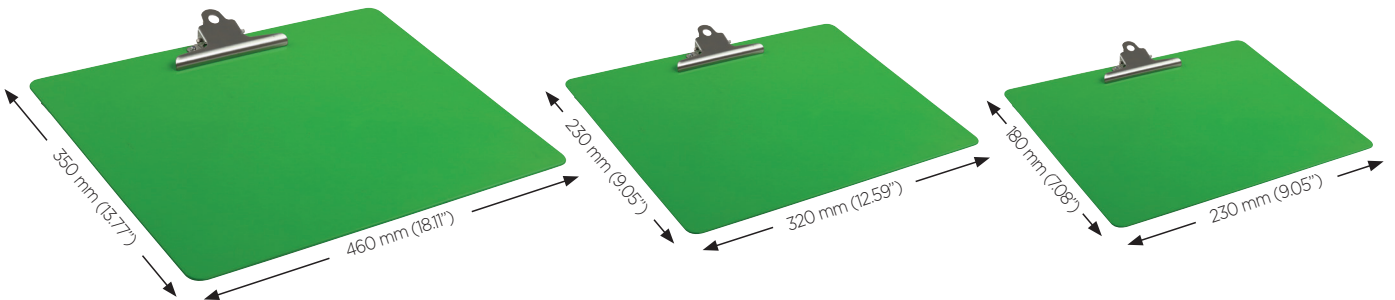

PORTRAIT OR LANDSCAPE

AVAILABLE IN ALUMINIUM, STAINLESS STEEL AND PLASTIC

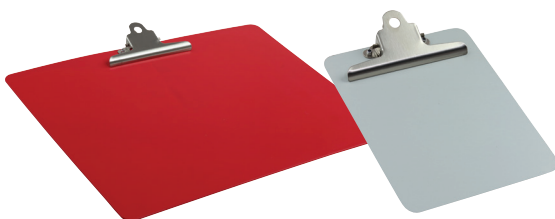

Colours:

PRODUCT CODE: 301



# Metal & X-Ray Detectable Stainless Steel or Aluminium Hanging Clipboard

FR: Tablettes suspendues en acier inoxydable et en aluminium

ES: Tablas sujetapapeles para colgar de acero inoxidable o aluminio

DE: Aufhängbare Klemmbretter aus Edelstahl und Aluminium



This stainless steel or aluminium hanging clipboard comes either folded or rolled for hanging.

## Features & Options



### A3 SIZE

350 x 460 mm  
(13.77 x 18.11")



PLEASE ASK  
US ABOUT  
BESPOKE SIZES

SUITABLE  
FOR LASER  
ENGRAVING

### A4 SIZE

230 x 320 mm  
(9.05 x 12.59")

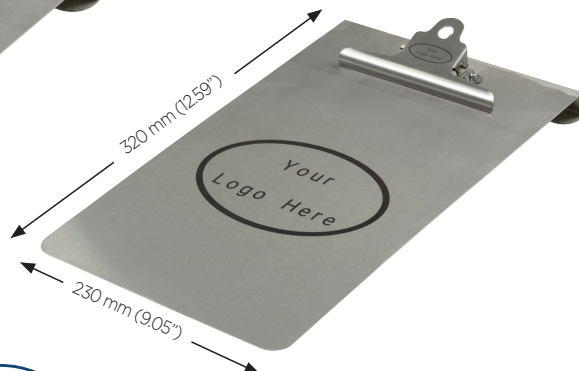

### ROLLED OPTION

suitable for hanging over bars up to 50 mm (2")



### ROLLED

55 x 40 mm  
(2.16 x 1.57")

### FOLDED OPTION

suitable for hanging over bars up to 18 mm (0.70")



### FOLDED

20 x 20 mm  
(0.78 x 0.78")

ANODISED ALUMINIUM  
& STAINLESS STEEL

Colour:

PORTRAIT OR  
LANDSCAPE



PRODUCT CODE: 300-O

In Partnership  
with

**BROGS**

55

**Detectamet**

# Metal Detectable & X-Ray Visible Stationery

## Metal Detectable & X-Ray Visible Ring Binder Clipboard

FR: Porte-bloc à anneaux

ES: Tabla sujetapapeles con archivador

DE: Ringordner-Klemmbrett

Keep documents together in processing areas with this detectable ring binder clipboard, available in a number of colours.



AVAILABLE WITH  
2, 3 OR 4 RINGS

### A5 SIZE

180 x 230 mm  
(7.08 x 9.05")

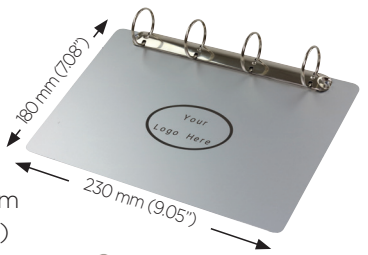

### A4 SIZE

230 x 320 mm  
(9.05 x 12.59")

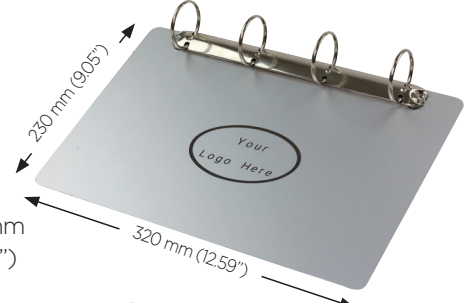

### A3 SIZE

350 x 460 mm  
(13.77 x 18.11")

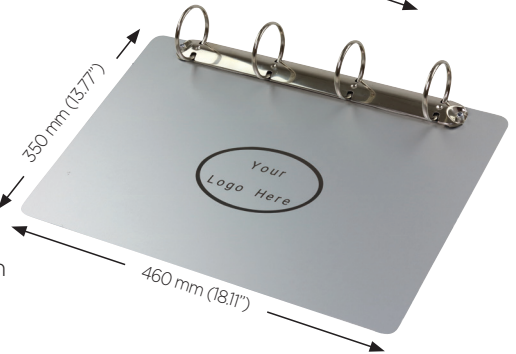

### Features & Options

1  
PACK

AVAILABLE IN PLASTIC, ANODISED ALUMINIUM & STAINLESS STEEL



SUITABLE FOR  
LASER ENGRAVING

Colours:

PRODUCT CODE: 300-

Sequential numbering available for all products • Ask us for a pen and knife guide

In Partnership with  
**BROGS**

56

## Metal Detectable & X-Ray Visible Magnetic Multi-Purpose Holders

FR: Support magnétique multifonctionnel

ES: Soporte magnético multiusos

DE: Detektierbare magnetische Klemmbretter

Strong magnetic multi-purpose holders for hanging paperwork on any ferrous surface e.g. whiteboards, machines, metal partitions etc.



SUITABLE FOR  
LASER ENGRAVING

INNER RING  
DIAMETER

43 mm (1.69")  
or 30 mm (1.18")

RING SPACING  
104 mm (4.09")

### Features & Options

10  
PACK

MAGNETIC BACKING  
FIXES TO METALLIC  
SURFACES



### SIZES:

324 x 75 x 67 mm  
(12.75 x 2.95 x 2.63")



AVAILABLE WITH  
2, 3 OR 4 RINGS

Colours: Rings:

PRODUCT CODE: 316-P42

etectamet

# Metal & X-Ray Detectable Ring Binder Mechanisms

FR: Mécanisme de reliure à anneaux chromés

ES: Mecanismo de archivado cromado

DE: Ringordner-Mechanismus aus Chrom

Keep your important documents bound together with these chrome plated ring binder mechanisms with 2, 3 or 4 rings. Please note that the ring diameter measurements listed are the internal dimensions.

## Features & Options

**10**  
PACK

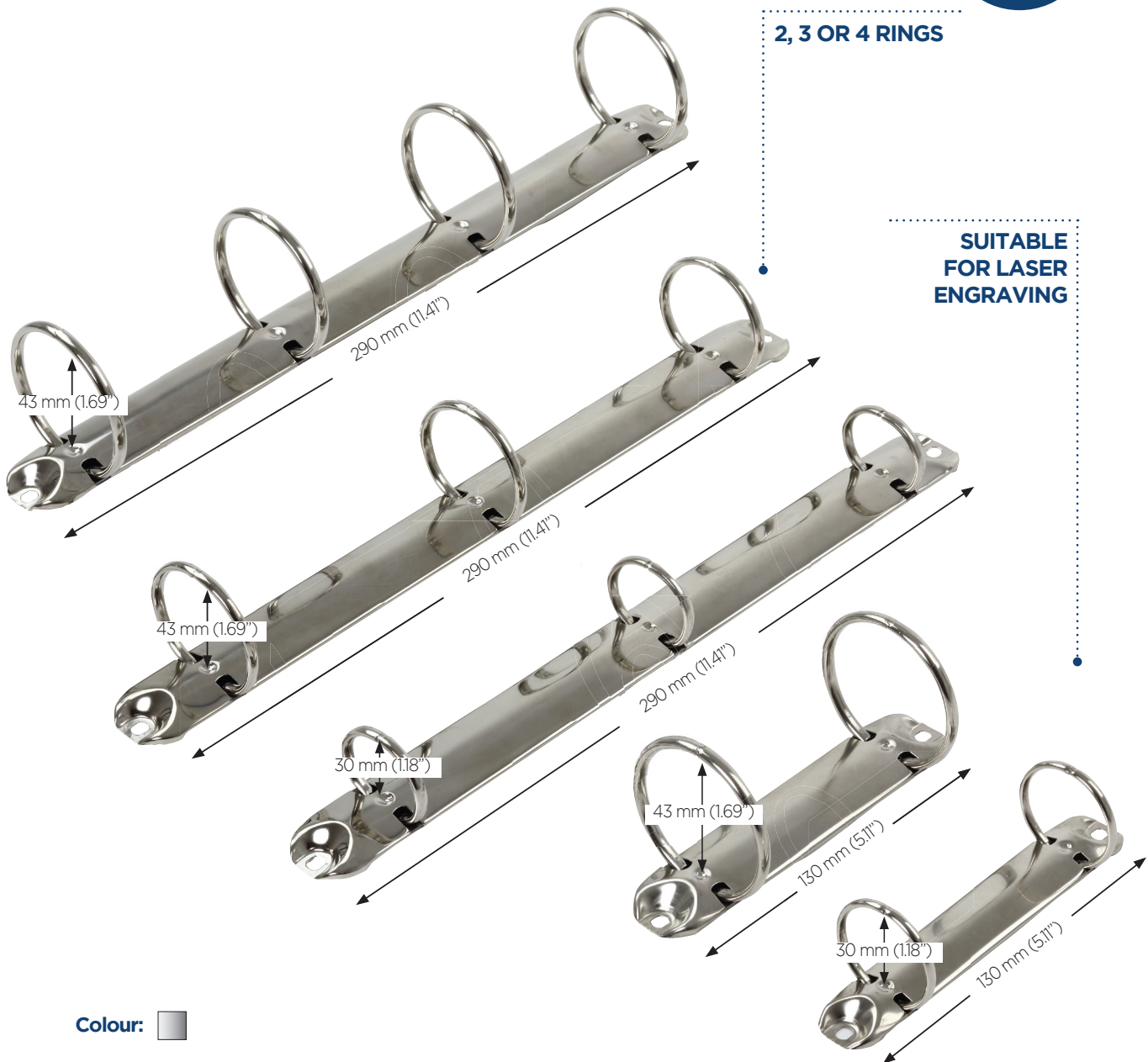

In Partnership with

**BREGS**

57

**Detectamet**

PRODUCT CODE: 316-P42-A

# Metal & X-Ray Detectable Stainless Steel or Aluminium Ring Binder

FR: Classeurs à anneaux en acier inoxydable et aluminium

ES: Archivadores con anillos de acero inoxidable y aluminio

DE: Ringordner aus Edelstahl und Aluminium

This 304 stainless steel or anodised aluminium ring binder is available with 2, 3 or 4 rings, and can be powder coated for your colour coding requirements.

In Partnership  
with  
**BRCS**

58

**Detectamet**

## Features & Options

**1**  
PACK

SUITABLE FOR  
LASER ENGRAVING

### A3 SIZE

297 x 420 mm  
(11.69 x 16.53")

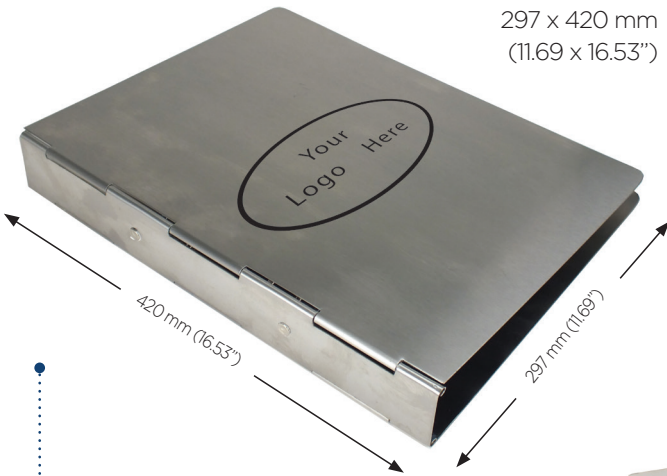

### A4 SIZE

210 x 297 mm  
(8.26 x 11.69")



HOLDS UP TO  
350 SHEETS OF  
80GSM PAPER



AVAILABLE WITH  
2, 3 OR 4 RINGS



PORTRAIT AND  
LANDSCAPE

Colours: 

PRODUCT CODE: 311-P



# Metal & X-Ray Detectable Stainless Steel or Aluminium Lever Arch File

FR: Classeurs en acier inoxydable et en aluminium

ES: Archivadores con anillos de acero inoxidable y aluminio

DE: Ringordner aus Edelstahl und Aluminium

A4 lever arch file, available in 304 stainless steel or anodised aluminium.

## Features & Options

1  
PACK

In Partnership  
with  
**BROS**

59

**Detectamet**

SUITABLE FOR  
LASER ENGRAVING

HOLDS UP TO  
700 SHEETS OF  
80GSM PAPER

### A4 SIZE

255 x 310 x 50 mm  
(10.03 x 12.20 x 1.96")



Colour:



310mm (12.20")

50 mm (1.96")

255mm (10.03")

RING  
SPACING  
76 mm (2.99")

RING DIAMETER  
AT HIGHEST POINT  
67 mm (2.63")

PRODUCT CODE: 317-P32-O18



# Metal & X-Ray Detectable Stainless Steel Wall Mountable Document Holder

FR: Support mural pour tablettes en acier inoxydable

ES: Bandeja de acero inoxidable de montaje en pared para tablas sujetapapeles

DE: Klemmbretthalterung aus Edelstahl zur Wandmontage

**Best Seller!**

This wall mountable stainless steel clipboard holder is available in either silver or powder coated in four different colours.

**1  
PACK**

## Features & Options

### HOLDS A3 OR A4 CLIPBOARDS

A3 size 297 x 420 mm (11.69 x 16.53")

A4 size 210 x 297 mm (8.26 x 11.69")



**WALL  
MOUNTABLE**

### SIZES:

247 x 243 x 40 mm (9.72 x 9.56 x 1.57")

holds two or three A4 clipboards

490 x 250 x 40 mm (19.29 x 9.84 x 1.57")

holds five or six A4 clip boards or three A3

Colours:

**PRODUCT CODE: 458**

In Partnership  
with  
**BRCS**

60

**etectamet**

## Metal Detectable & X-Ray Visible Envelope Style Document Holder

FR: Porte-dossier mural

ES: Bandejas para carpetas de montaje en pared

DE: Wandmontierte Aktenablagen

A wall mountable, detectable plastic clipboard holder, available in a range of colours.



PORTRAIT OR  
LANDSCAPE



### Features & Options

1  
PACK



WALL  
MOUNTABLE

SUITABLE  
FOR LASER  
ENGRAVING

SIZE:

220 x 310 x 25 mm  
(8.66" x 12.20 x 0.98")

HOLDS A4  
CLIPBOARD

Colours:



PRODUCT CODE: 437-005

More product codes available – please contact us for a full price list

## Metal Detectable & X-Ray Visible Aluminium Flip Chart

FR: Tableau à feuilles en aluminium

ES: Rotafolios de aluminio

DE: Flip-Charts aus Aluminium

Anodised aluminium flip charts, available in A3 and A4, with either 2, 3 or 4 rings.

SIZES:

A3 size 457 x 355 mm (17.99 x 13.97")  
A4 size 355 x 255 mm (13.97 x 10.03")

CHOOSE FROM  
2, 3 OR 4 RINGS  
with inner dia. of  
30 mm (1.18") or  
43 mm (1.69")

### Features & Options

1  
PACK

PORTRAIT OR  
LANDSCAPE

SUITABLE  
FOR LASER  
ENGRAVING



Colour:



PRODUCT CODE: 315-004

# Pen Refills



**We sell refills!**

## Fully Detectable Pen Refills

Our patent pending pen refills were the first on the market to be fully detectable, including the end cap.

### Features & Options

**100  
PACK**



#### Ink type: standard

Colour	Product Code
	100-I51
	100-I52
	100-I53
	100-I54

**MANUFACTURED FROM  
DETECTABLE SHATTER  
PROOF PLASTIC**

#### Ink type: fine tip

Colour	Product Code
	100-I71
	100-I72

**WRITE OUT LENGTH  
APPROX. 9,400M  
(30,840')**

**FULLY DETECTABLE -  
INCLUDING END CAP**

#### Available for:

- HD retractable pen
- Elephant retractable pen
- Stainless steel retractable pen
- Metal stick pen



# Metal Detectable Stickers

FR: Autocollants

ES: Pegatinas

DE: Aufkleber



In need of metal detectable stickers for use in food processing areas? We can manufacture any sized detectable stickers. This is a bespoke product so please talk to a sales representative for more details.

**METAL  
DETECTABLE  
WITH ALUMINIUM  
STRIP**



**AVAILABLE IN  
CUSTOM SIZES.  
PLEASE GET IN  
TOUCH TO FIND  
OUT MORE**

## Features & Options

- Metal Detectable
- Strong adhesive qualities for varying environments
- Temperature resistance -10°C to 70°C (14°F to 158°F)
- Size: this is a bespoke product - any size is possible

Colours:

**PRODUCT CODE: 405-S**



In Partnership  
with

**BREGS**

**63**

**Detectamet**



# Metal & X-Ray Detectable Wall Mountable File Pocket

FR: Porte-dossier mural

ES: Bandejas para carpetas de montaje en pared

DE: Wandmontierte Aktenablagen



This detectable wall mounted file pocket is cleverly designed to allow multiple files to be stored near to where you need them.

## Features & Options



In Partnership with  
**BRCS**

64

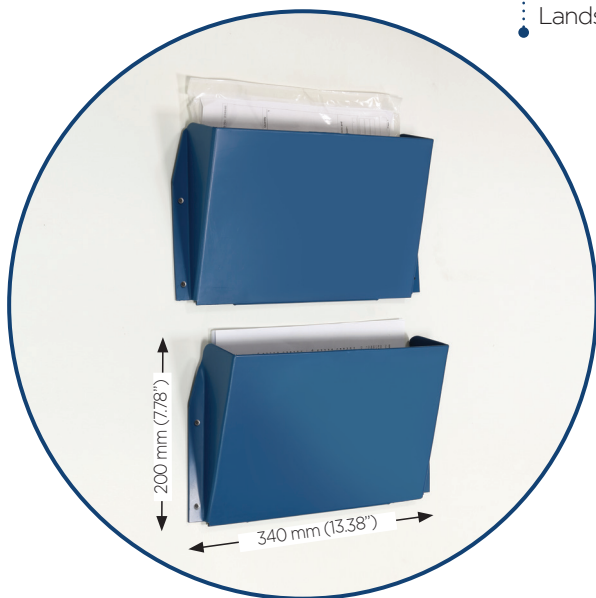

**ORIENTATION:**  
Landscape or Portrait

**SUITABLE FOR STORING:**  
A4 (8.25 x 11.69")  
files and clipboards



**ALSO  
AVAILABLE  
IN STAINLESS  
STEEL**

**MANUFACTURED  
FROM PLASTIC  
POLYMER WITH  
A DETECTABLE  
ADDITIVE**

**EASY TO KEEP  
HYGIENICALLY CLEAN**

**SIZES:**

A4 Landscape: 340 x 200 x 60 mm  
(13.38 x 7.78 x 2.36")

A4 Portrait: 275 x 272 x 75 mm  
(10.82 x 10.70 x 2.95")

A5 Landscape: 272 x 165 x 80 mm  
(10.70 x 6.49 x 3.14")

A5 Portrait: 200 x 192 x 60 mm  
(7.87 x 7.55 x 2.36")

**SUITABLE FOR STORING:**

A4 (8.25 x 11.69") or A5 (5.81 x 8.25") files  
and clipboards



**PRODUCT CODE:** 322-PO (PLASTIC) / 322-P32 (STAINLESS STEEL)

etectamet



## Portable “Cling Easy” Whiteboard Material

**FR:** Tableau blanc portable facile à accrocher  
**ES:** Pizarra blanca portátil de fácil sujeción  
**DE:** Tragbares „leicht haftendes“ Whiteboard

1  
ROLL

Use this “Cling Easy” Whiteboard Material to create a whiteboard where you want it.

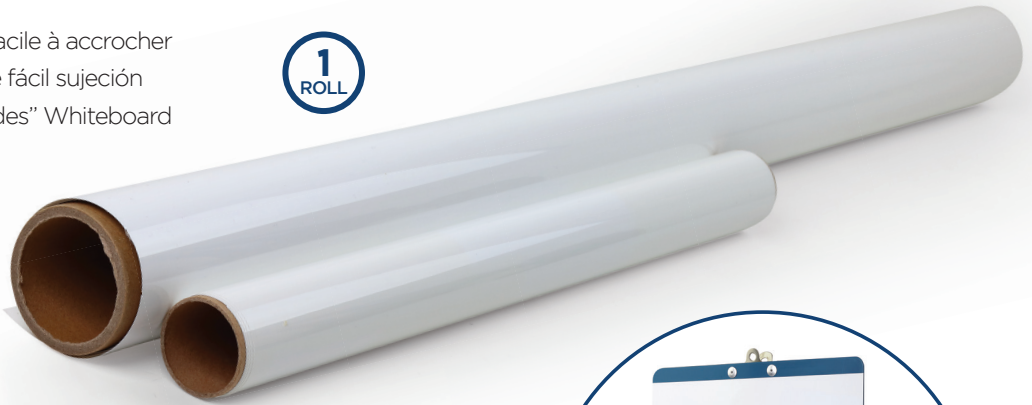

### Features & Options

- Suitable for smooth surfaces including our range of clipboards and files
- Removable and reusable with no damage to base surface
- Dirt on suction layer can be removed to allow reuse
- Suitable for temperatures between -40 to 100°C (-40°F to 212°F)
- Sizes:  
 Small 600 x 450 mm (23.62 x 17.71")  
 Large 1200 x 900 mm (47.24 x 35.43")

Colour:

**PRODUCT CODE:** 306-S121 (small), 306-S112 (large)

More product codes available – please contact us for a full price list

In Partnership with  
**BROGS**

65

## Metal Detectable & X-Ray Visible Stainless Steel & Aluminium Recipe Card Holder

**FR:** Range-cartes de recettes en acier inoxydable et en aluminium  
**ES:** Soporte de aluminio y acero inoxidable para recetas  
**DE:** Rezeptkartenhalter aus Edelstahl und Aluminium

1  
PACK

This A4 wall mountable recipe card holder is available in stainless steel or anodised aluminium.



**HOLDS A4 DOCUMENTS**

**SIZE:**  
 220 x 312 mm (8.66 x 12.28")  
 Loading capacity  
 4 mm (0.15)

Colour:



**SUITABLE FOR LASER ENGRAVING**

**PRODUCT CODE:** 320-O18-P32

**detectamet**

## Metal Detectable & X-Ray Visible Stainless Steel Multi-Purpose Utility Stand

FR: Support multi-usage en acier inoxydable

ES: Soporte de uso general y  
multifunción de acero inoxidable

DE: Mehrzweckständer aus Edelstahl

A stainless steel multi-purpose utility stand  
perfect for holding recipe cards etc.



**SUITABLE  
FOR LASER  
ENGRAVING**

### Features & Options

**1  
PACK**



**HOLDS A4  
DOCUMENTS**

Colour: 

**SIZE (OF FRONT):**  
115 x 155 x 35 mm  
(4.52 x 6.10 x 1.37")

**PRODUCT CODE:** 598-P49

Sequential numbering available for all products • Ask us for a pen and knife guide

## Metal Detectable & X-Ray Visible Storage Clipboard

FR: Tablette avec rangement portable

ES: Tabla sujetapapeles portátil con espacio de almacenamiento

DE: Tragbares Klemmbrett mit Aufbewahrungsfunktion

A detectable, water resistant storage clipboard  
designed to protect documents that need to be in  
food processing areas.

**SIZES:**  
405 x 255 x 35 mm  
(15.94 x 10.03 x 1.37")  
plus clip

**CLIP ALLOWS  
USE AS A  
CLIPBOARD**

### Features & Options

**1  
PACK**



**SUITABLE  
FOR LASER  
ENGRAVING**



**HOLDS A4  
DOCUMENTS**

Colour: 

**PRODUCT CODE:** 302-T184-P01-A12

# Metal & X-Ray Detectable Stainless Steel File Holder

FR: Porte-dossiers en acier inoxydable

ES: Caja de archivadores de acero inoxidable

DE: Aktenablagen aus Edelstahl

This 304 stainless steel file holder is available in three sizes, allowing files to be stored near where they are needed.

## Features & Options

1  
PACK

### SIZE:

3 files 280 x 380 x 250 mm (11.02 x 14.96 x 9.84")  
4 files 370 x 380 x 250 mm (14.56 x 14.96 x 9.84")  
5 files 450 x 380 x 250 mm (17.71 x 14.96 x 9.84")  
Compartment width 90 mm (3.54")

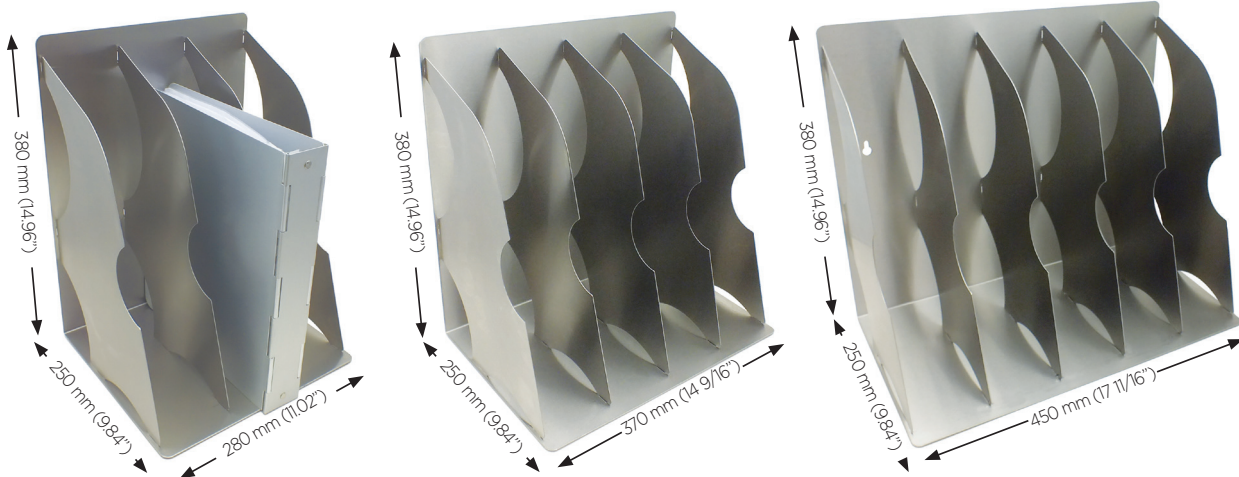

HOLDS LEVER  
ARCH FILES

SUITABLE FOR  
LASER ENGRAVING

HOLDS 3, 4  
AND 5 FILES

Colour:

PRODUCT CODE: 312-P32

In Partnership  
with

**BROGS**

67

**Detectamet**



## Metal Detectable & X-Ray Visible Stainless Steel File Holder with Hanging Hook

**FR:** Support pour dossier en acier inoxydable avec crochet de suspension  
**ES:** Bandejas de pared para carpetas de acero inoxidable con gancho para colgar  
**DE:** Edelstahl-Aktenablage mit Aufhängehaken

This stainless steel file holder has a hanging hook, allowing files to be stored near to where they are required.

**HANGING HOOK  
TO FIT OVER BAR  
40MM DEEP**

**HOLDS A LEVER  
ARCH FILE**

### Features & Options

**1  
PACK**

**ALSO AVAILABLE WITH  
RIVET FOR ATTACHING  
DIRECTLY TO THE WALL  
WITHOUT HANGING  
HOOK**



Colour:

**PRODUCT CODE:** 595-A98

Sequential numbering available for all products • Ask us for a pen and knife guide

## Metal Detectable & X-Ray Visible Stainless Steel Filing Tray

**FR:** Plateaux classeurs en acier inoxydable  
**ES:** Bandejas de acero inoxidable para archivar documentos  
**DE:** Dokumenten-Ablagen aus Edelstahl

This 304 stainless steel filing tray is stackable and available in two sizes.

**SIZES:**  
 Bottom tray 240 x 420 x 90 mm  
 (9.44 x 16.53 x 3.54")  
 Stackable tray 240 x 340 x 90 mm  
 (9.44 x 13.38 x 3.54")

### Features & Options

**1  
PACK**

**SUITABLE FOR  
LASER ENGRAVING**

**STACKABLE**

**HOLDS A4 SIZED  
DOCUMENTS**

Colour:



**PRODUCT CODE:** 321-P32

# Metal Detectable & X-Ray Visible Workwear & PPE



**FR:** Vêtements de travail & epi

**ES:** Ropa de trabajo y equipo de protección personal

**DE:** Arbeitskleidung & PSA

69

Vinyl Gloves	70	Litter-Free Wristband	93
Rubber Gloves	70	Lightweight Safety Glasses	94
Nitrile Gloves with Seamless Cuffs	72	Ultra Lightweight Safety Glasses	94
Nitrile Gloves with Woven Cuffs	73	Lightweight Over Glasses	94
Reusable Nitrile Gloves	74	Glasses Cord	94
Stainless Steel Glove Dispenser	75	Utility Clips	96
Plastic Glove Dispenser	76	Ear Savers	97
Plasters/Bandages	77	Face Mask Spacer / Bracket	98
Reusable Earplugs 2 or 3 Flange	78	Face Coverings	99
Reusable Earplugs 3 Flange	79	Face Mask Dispenser	100
Reusable Earplugs 'Clean Ear' System	80	Multi-Purpose Dispenser	101
Expandaband	81		
Earplug Box	82		
Disposable Ear Plugs	82		
Ear Plug Dispenser	83		
Face Shields	84		
Beard Snoods	86		
Balaclava Hoods Mob/Bouffant Caps	87		
Hairnets	88		
Hairnets with Neck Guard	89		
Disposable Aprons	90		
Reusable Apron	90		
Disposable Sleeve Covers	91		
Reusable Sleeve Covers	91		
Shoe Covers	92		
Glove Tensioners	92		
Rubber Bands	92		



# Metal Detectable Disposable Vinyl Gloves

FR: Gants en vinyle alimentaires

ES: Guantes de vinilo para manipulación de alimentos

DE: Vinylhandschuhe für den Lebensmittelbereich

These **patented** metal detectable disposable gloves, available in four sizes, are powder free and manufactured from food safe latex free vinyl.

## Features & Options

100  
PACK

Best  
Seller!

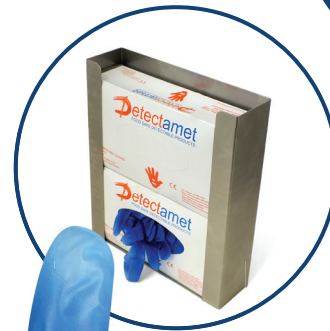

LATEX FREE

DETECTABLE  
POWDER FREE VINYL

DISPOSABLE

NOT SUITABLE  
FOR USE WITH  
FATTY FOODS

SUITABLE FOR USE  
UP TO 40°C (104°F)

MANUFACTURED  
FROM EU & FDA  
APPROVED FOOD  
CONTACT MATERIAL

FREE SAMPLES  
AVAILABLE



SIZES:  
Small, medium, large,  
extra large

THICKNESS:  
5.5mils approx.

COLOUR:



PRODUCT CODE: 450-A65

In Partnership  
with  
**BRGS**

70

**Detectamet**

# Metal Detectable Natural Rubber Gloves

FR: Gants en caoutchouc naturel

ES: Guantes de caucho natural

DE: Handschuhe aus Naturgummi

These reusable powder free rubber gloves are available in five sizes and are easy to pull on and off making them reusable to cut down on wastage.

REUSABLE

12 Pair  
PACK

## Features & Options

CAN BE STERILISED USING AUTOCLAVE MACHINES, AS WELL AS SOLVENTS.

SUITABLE FOR USE BETWEEN -30°C TO 40°C (-22°F TO 104°F).

MANUFACTURED FROM EU & FDA APPROVED FOOD CONTACT MATERIALS

FREE SAMPLES AVAILABLE

SUITABLE FOR USE WITH ACIDIC AND FATTY FOODS

POWDER FREE NATURAL RUBBER

METAL DETECTABLE THROUGHOUT. MINIMUM DETECTABLE PIECE 5 MM X 5 MM.

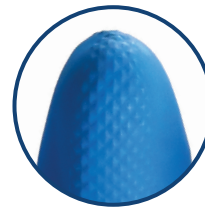

ANTI-SLIP TEXTURED GRIP

ANTI-SLIP PATTERN FOR GOOD GRIP IN WET AND DRY CONDITIONS



SIZES:

6-6.5, 7-7.5, 8-8.5, 8-8.5, 9-9.5, 10

THICKNESS: 17.7mils

COLOUR:

(Other colours subject to MOQ)



In Partnership with

**BROGS**

71

**Detectamet**

PRODUCT CODE: 467-S88

# Metal & X-Ray Detectable Nitrile Gloves with Seamless Cuffs

**FR:** Gants en nitrile à manchettes sans coutures aux normes alimentaires

**ES:** Guantes de nitrilo sin costura en puño aptos para manipulación de alimentos

**DE:** Lebensmittelechte nahtlose Nitrilhandschuhe mit Bund

These cotton lined, reinforced, detectable nitrile gloves are available in three lengths and are suitable for both indoor and outdoor use.

## Features & Options

**1 Pair**  
PACK



**SIZES:**  
7, 8, 9, 10, 11

**FREE SAMPLES AVAILABLE**

**AVAILABLE IN CUFF, ELBOW AND SHOULDER LENGTHS**

**REUSABLE**



**SHOULDER**

**ELBOW**

**CUFF**

**ANTI-SLIP TEXTURED GRIP**

**SUITABLE FOR USE IN OILY AND GREASY ENVIRONMENTS**

**THICKNESS:**  
47.2 mils

**POWDER FREE NATURAL RUBBER**

**OFFER PROTECTION AGAINST MECHANICAL RISKS**

**COLOUR:** 

In Partnership with  
**BRGS**

**72**

**etectamet**

**PRODUCT CODE:** 455-A100

# Metal & X-Ray Detectable Nitrile Gloves with Woven Cuffs

**FR:** Gants en nitrile à manchettes cousues aux normes alimentaires

**ES:** Guantes de nitrilo con costura en puño aptos para manipulación de alimentos

**DE:** Lebensmittelechte Nitrilhandschuhe mit Strickbund

These heat proof, woven cuff, nitrile detectable gloves are available either partially or fully coated.

## Features & Options

**1 Pair**  
PACK



**SIZES:**

7, 8, 9, 10, 11

(11 available in part coated only)

**FREE SAMPLES AVAILABLE**

**SUITABLE FOR USE IN OILY AND GREASY ENVIRONMENTS**

**REUSABLE**

**THICKNESS:**

47.2 mils

**ANTI-SLIP TEXTURED GRIP**

**100% INTERLOCK LINING**

**PARTIALLY OR FULLY COATED**

**OFFERS PROTECTION AGAINST MECHANICAL RISKS**

**COLOURS:**



In Partnership with

**BREGS**

**73**

**detectamet**

**PRODUCT CODE:** 455-A101



# Metal & X-Ray Detectable Reusable Nitrile Gloves

**Best Seller!**

**FR:** Gants en nitrile réutilisables  
**ES:** Guantes de nitrilo reutilizables  
**DE:** Wiederverwendbare nitrilhandschuhe

We have introduced these NEW gloves due to customer demand. These reusable gloves are patent protected and suitable for use in oily and greasy environments.

## Features & Options

**12 Pair PACK**

In Partnership with  
**BRGS**

74

**etectamet**

**REUSABLE**

**PATENTED AND PATENT APPLICATIONS PENDING WORLDWIDE**

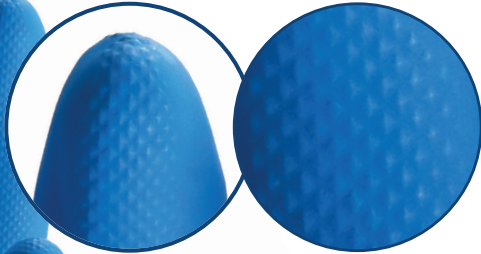

**METAL DETECTABLE THROUGHOUT. MINIMUM DETECTABLE PIECE 10 MM X 10 MM.**

**MANUFACTURED FROM EU & FDA APPROVED FOOD CONTACT MATERIALS**

**CAN BE STERILIZED USING AUTOCLAVE MACHINES, AS WELL AS SOLVENTS.**

**SIZES:**  
6, 7, 8, 9, 10, 11

**THICKNESS:**  
14.9 mils

**SUITABLE FOR USE BETWEEN -10°C TO 40+°C (14°F TO 104+°F)**

**ANTI-SLIP PATTERN FOR GOOD GRIP IN WET AND DRY CONDITIONS**

**SUITABLE FOR USE IN OILY AND GREASY ENVIRONMENTS**

**FREE SAMPLES AVAILABLE**

**COLOUR:** 

**POWDER FREE**

**PRODUCT CODE: 434**

# Metal & X-Ray Detectable Stainless Steel Glove Dispenser

FR: Distributeurs de gants en acier inoxydable

ES: Expendedores de guantes de acero inoxidable

DE: Handschuhspender aus Edelstahl

This stainless steel, metal detectable and X-ray visible glove dispenser is wall mountable or hanging and can hold up to four boxes of detectable gloves, keeping your processing area tidy.

**1**  
PACK

## Features & Options

### HANGING HOOK - FOLDED OR ROLLED

Folded hanging hook option suitable for bars up to 30 mm (1.18") diameter. Rolled hanging hook option suitable for bars up to 45 mm (1.77") diameter



### TO FIT STANDARD BOXES OF 100 GLOVES



### CHOICE OF 1, 2, 3 OR 4 BOX CAPACITIES

### OPEN OR ENCLOSED DISPENSERS AVAILABLE

SUITABLE FOR LASER ENGRAVING

SIZE	WIDTH	DEPTH	HEIGHT
1 box	250 mm (9.84")	70 mm (2.75")	140 mm (5.51")
2 boxes	250 mm (9.84")	70 mm (2.75")	290 mm (11.41")
3 boxes	250 mm (9.84")	70 mm (2.75")	430 mm (16.92")
4 boxes	250 mm (9.84")	70 mm (2.75")	580 mm (22.83")

Colour: 

**PRODUCT CODE: 454-A**

In Partnership with

**BROGS**

**75**

**Detectamet**

# Metal & X-Ray Detectable Plastic Glove Dispenser

FR: Distributeurs de gants

ES: Expendedores de guantes

DE: Handschuhspender

This metal detectable and X-ray visible glove dispenser is available in nine colours, is wall mountable or hanging, and can hold up to four boxes of detectable gloves, keeping your processing area tidy.

## Features & Options

**1**  
PACK

**Made In:**  
UK   
USA 

CHOICE OF  
1, 2, 3 OR 4  
BOX CAPACITIES

TO FIT STANDARD  
BOXES OF 100  
GLOVES



WALL MOUNTABLE  
OR WITH INTEGRATED  
HANGING HOOK

HANGING HOOK OPTION  
SUITABLE FOR BARS UP TO  
30 MM (1.18") DIAMETER

OPEN OR  
ENCLOSED

SUITABLE  
FOR LASER  
ENGRAVING

SIZE	WIDTH	DEPTH	HEIGHT
1 box	250 mm (9.84")	70 mm (2.75")	140 mm (5.51")
2 boxes	250 mm (9.84")	70 mm (2.75")	290 mm (11.41")
3 boxes	250 mm (9.84")	70 mm (2.75")	430 mm (16.92")
4 boxes	250 mm (9.84")	70 mm (2.75")	580 mm (22.83")

Colours: 

**PRODUCT CODE:** 451-A15

# Metal & X-Ray Detectable Plasters / Bandages

**FR:** Pansements détectables

**ES:** Tiritas detectables

**DE:** Metalldetektierbare Heftpflaster

Hygiene is of paramount importance in the food processing industry.

Our innovative range of detectable plasters are blue in colour and offer a dual detection system, making them detectable by both metal and X-Ray inspection systems – required under BRCGS Issue 8. They are also fully FDA 21 CFR Part 807 approved.

Available in eight popular sizes, these detectable plasters come in packs of 50 or 100 dependent on size. We also offer an assorted pack of 100 containing multiple sizes.

Colour: 



DESCRIPTION	PACK SIZE	PRODUCT CODE
Detectable Plasters 38 mm x 38 mm (1.49 x 1.49")	100	403-S124-X11
Detectable Plasters 19 mm x 63 mm (0.74 x 2.48")	100	403-S731-X11
Detectable Plasters 30 mm x 64 mm (1.18 x 2.51")	100	403-S732-X11
Detectable Plasters 19 mm x 72 mm (0.74 x 2.83")	100	403-S733-X11
Detectable Plasters 25 mm x 72 mm (0.98 x 2.83")	100	403-S734-X11
Detectable Plasters 38 mm x 72 mm (1.49 x 2.83")	50	403-S735-X09
Detectable Plasters 51 mm x 72 mm (2.00 x 2.83")	50	403-S736-X09
Detectable Plasters Finger 20 mm x 120 mm (0.78 x 4.72")	50	403-S737-X09
Detectable Plasters Assorted Pack Multiple Sizes	100	403-S738-X11



# Metal & X-Ray Detectable Reusable Earplugs - Two or Three Flange

FR: Bouchons d'oreille réutilisables - 2 ou 3 collerettes  
ES: Taponos para oídos reutilizables con 2 o 3 rebordes  
DE: Wiederverwendbare Ohrenstöpsel - 2 oder 3 Flansche



These 100% detectable earplugs are fully detectable, including the cord.

## Features & Options



TWO OR THREE FLANGE PROTECTION

SNR 24 DB (EN352-2:2002) TWO FLANGE

SNR 23 DB (EN352-2:2002) THREE FLANGE

EARPLUGS ARE FULLY DETECTABLE, INCLUDING THE CORD

CORD LENGTH: 600 MM (23.62")

ERGONOMIC FOR A PERFECT FIT

AVAILABLE LOOSE OR WITH CORD

MEDICAL GRADE LATEX FREE SILICONE RUBBER

FREE SAMPLES AVAILABLE

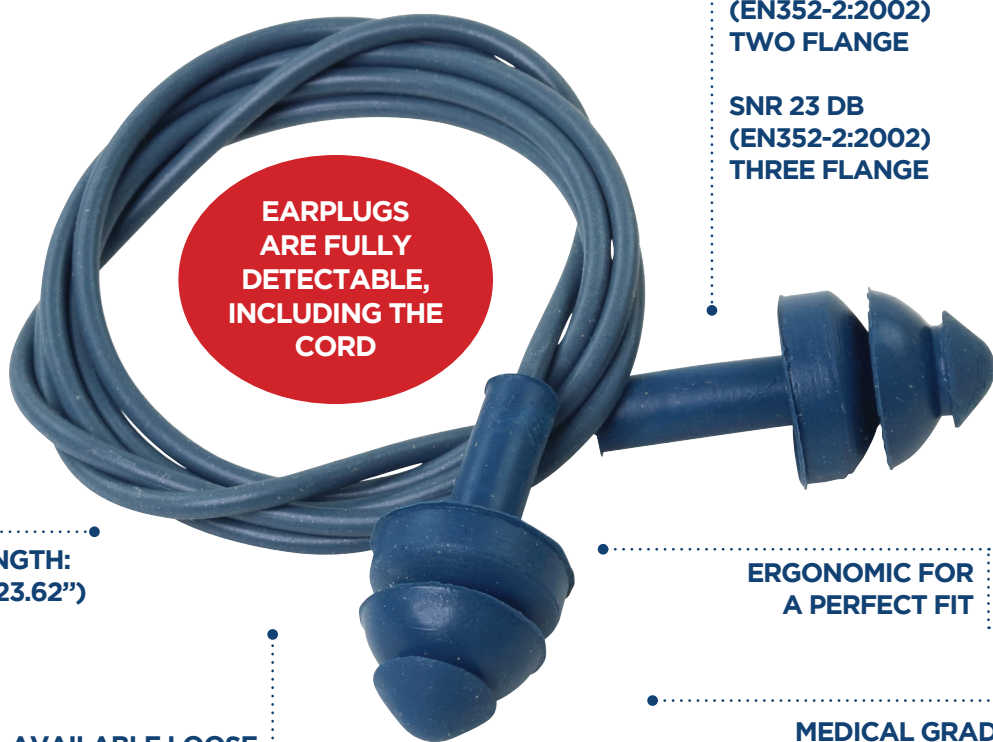

In Partnership with BRCS

78

etectamet

Cord: [blue square] [red square] Earplugs: [blue square] [red square]

PRODUCT CODE: 410-P20

# Metal & X-Ray Detectable Reusable Earplugs - Three Flange

FR: Bouchons d'oreille réutilisables - 3 collerettes  
ES: Tapones para oídos reutilizables con 3 rebordes  
DE: Wiederverwendbare Ohrenstöpsel - 3 Flansche



Earplugs have metal bearing inside for detectability. Earplug cord is 100% detectable.

## Features & Options

**250**  
PAIR PACK

**METAL**  
DETECTABLE

**X-RAY**  
VISIBLE

THREE FLANGE  
PROTECTION

NRR 26 DB (ANSI S3.19-  
1974) THREE FLANGE

EARPLUG  
CORD IS FULLY  
DETECTABLE

New  
Product!

CORD LENGTH:  
700 MM (27.55")

ONLY AVAILABLE  
WITH CORD

FREE SAMPLES  
AVAILABLE

ERGONOMIC FOR  
A PERFECT FIT

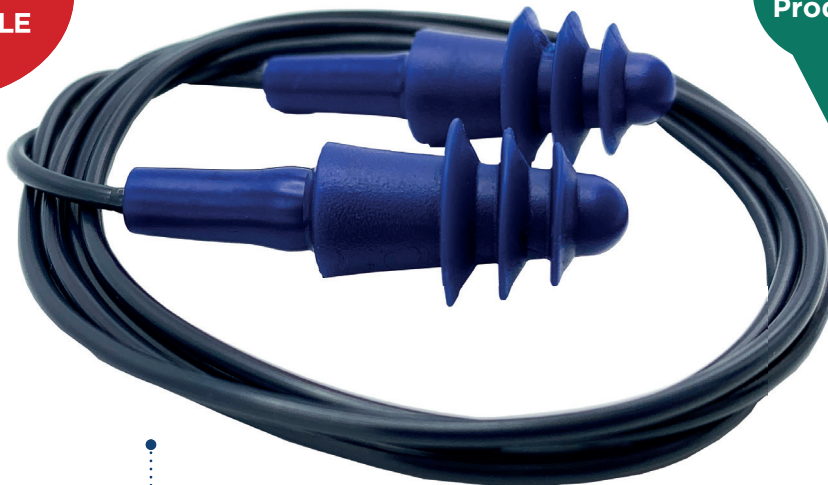

Cord:

Earplugs:

PRODUCT CODE: 410-P01-S975-X29

In Partnership  
with

**BROGS**

79

**Detectamet**

# Metal & X-Ray Detectable Hygienic 'Clean Ear' System Reusable Earplugs

FR: Bouchons d'oreille réutilisables - 2 ou 3 collerettes  
ES: Taponos para oídos reutilizables con 2 o 3 rebordes  
DE: Wiederverwendbare Ohrstöpsel - 2 oder 3 Flansche



These fully detectable, hygienic earplugs are **designed to prevent cross contamination of ear infections using a different colour plug for each ear.**

## Features & Options



TWO OR THREE FLANGE PROTECTION

SNR 24DB (EN352-2:2002) TWO FLANGE

SNR 23 DB (EN352-2:2002) THREE FLANGE

**EARPLUGS ARE FULLY DETECTABLE, INCLUDING THE CORD**

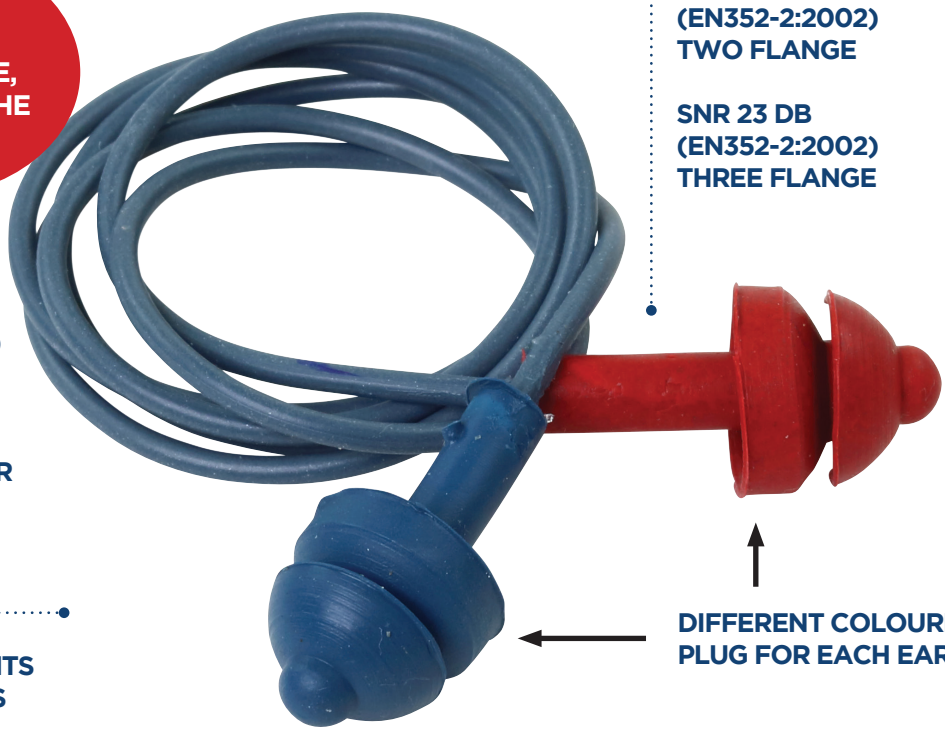

CORD LENGTH: 600 MM (23.62")

ERGONOMIC FOR A PERFECT FIT

"CLEAN EAR" SYSTEM PREVENTS EAR INFECTIONS

DIFFERENT COLOURED PLUG FOR EACH EAR

MEDICAL GRADE LATEX FREE SILICONE RUBBER

FREE SAMPLES AVAILABLE

Cord: ■ ■ Earplugs: ■ ■

PRODUCT CODE: 410-P21

In Partnership with  
**BRCS**

80

etectamet

# Metal & X-Ray Detectable Expandaband Earplugs

FR: Bouchons d'oreille à bandeau extensible

ES: Tapones para oídos Expandaband

DE: Gebänderte Elastik-Ohrenstöpsel



This unique, fully detectable earplug system has adjustable band to provide comfortable pressure of earplug into the ear canal for the user.



## Features & Options



**TWO OR THREE FLANGE PROTECTION**  
**SNR 24DB (EN352-2:2002)**  
**TWO FLANGE**

**SNR 23 DB (EN352-2:2002)**  
**THREE FLANGE**

**EXPANDABAND IS FULLY DETECTABLE, INCLUDING THE BAND**



**ADJUSTABLE BAND FOR ALTERING PRESSURE INTO CANAL TO SUIT USER**

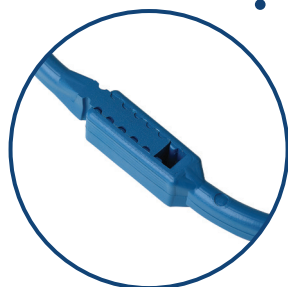

**INTELLIGENT DESIGN PREVENTS CONTACT WITH SURFACES WHEN NOT IN USE**

**MEDICAL GRADE LATEX FREE SILICONE RUBBER**

**REPLACEMENT PLUGS AVAILABLE**



**ERGONOMIC FOR A PERFECT FIT**

Earplug Colours:

Band Colours:

**PRODUCT CODE: 413-S01**



## Metal Detectable & X-Ray Visible Earplug Storage Boxes

FR: Boîte de rangement de bouchons d'oreille

ES: Caja de almacenamiento de tapones para oídos

DE: Aufbewahrungsbox für Ohrenstöpsel

Made from fully detectable polymer these earplug storage boxes have two sections to identify left and right ears and three drain holes, making them suitable for freshly washed earplugs.

**REUSABLE**

### Features & Options

**25**  
PACK



**SIZE:**

63 x 42 x 24 mm  
(2.48 x 1.65 x 0.94")

**SUITABLE FOR USE WITH A SPLIT RING OR SAFETY CHAIN**  
(additional charge applicable)



Colours:

**PRODUCT CODE:** 416-A65-S159-P01

More product codes available – please contact us for a full price list

## Metal Detectable & X-Ray Visible Disposable Earplugs

FR: Bouchons d'oreille en mousse

ES: Tapones de espuma para oídos

DE: Schaumstoff-Ohrenstöpsel

These disposable foam earplugs are detectable and available with or without detectable cord.

**FREE FROM LATEX SILICONE AND PHTHALATES**

**SNR 38DB**  
(EN352-2:2002)

**NRR 33DB**  
(ANSI S3.1974)

**SLC80 23DB**  
(AS/NZS 1270:2002)

### Features & Options

**250**  
PACK

**FREE SAMPLES AVAILABLE**

**EARPLUGS ARE FULLY DETECTABLE, INCLUDING THE CORD**

**AVAILABLE LOOSE OR WITH CORD**

**CORD LENGTH: 700 MM (27.55")**



Cord: Earplugs:

**PRODUCT CODE:** 412-PO

# Metal & X-Ray Detectable Earplug Dispenser

FR: Distributeur de bouchons d'oreille

ES: Dispensador de tapones para los oídos

DE: Ohrstöpselspender



Metal and X-ray detectable ear plug dispenser. Comfortably holds 30 pairs of ear plugs. Wall mountable with 2 screw holes at the back. Available in 9 colours.

## Features & Options



WALL-MOUNTABLE

2 SCREW HOLES AT THE BACK



PRODUCT CODE: 422-1241

In Partnership with  
**BROS**

83

**Detectamet**



# Face Shield / Visor with Metal & X-Ray Detectable Strap

FR: Masque de protection

ES: Careta

DE: Gesichtsschutz



Adjustable with the ergonomic silicone strap. Lightweight design supplied with detectable sponge for added comfort. Ideal for food manufacturing environments. Provides barrier protection from airborne aerosol droplets. This product does not provide mechanical protection from flying objects and debris.

## Features & Options

10 PACK

REUSABLE

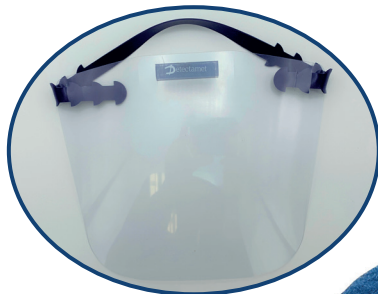

SILICONE STRAP AND SPONGE ARE METAL AND X-RAY DETECTABLE



NOTCHED DETECTABLE SILICONE STRAP FOR ADJUSTABILITY

SUITABLE FOR USE WITH PROTECTIVE HEADWEAR

BARRIER PROTECTION FROM AIRBORNE AEROSOL DROPLETS

WITH DETECTABLE SPONGE PADDING FOR ADDED COMFORT

Strap:



In Partnership with BRCS

84

etectamet

PRODUCT CODE: 460F-P01

# Pen Refills

## Fully Detectable Pen Refills

Our patent pending pen refills were the first on the market to be fully detectable, including the end cap.



**We sell refills!**





### Features & Options

**100  
PACK**



In Partnership with  
**BROGS**

#### Ink type: standard

Colour	Product Code
	100-I51
	100-I52
	100-I53
	100-I54

**MANUFACTURED FROM  
DETECTABLE SHATTER  
PROOF PLASTIC**

#### Ink type: fine tip

Colour	Product Code
	100-I71
	100-I72

**WRITE OUT LENGTH  
APPROX. 9,400M  
(30,840')**

#### Available for:

- HD retractable pen
- Elephant retractable pen
- Stainless steel retractable pen
- Metal stick pen

**FULLY DETECTABLE -  
INCLUDING END CAP**



**85**

**etectamet**  



## Metal Detectable Mesh Beard Snoods

FR: Écharpes à barbe maillées Detectanet™  
ES: Redecilla en malla para barba Detectanet™  
DE: Detectanet™ Bartschutz aus Netzmaterial

These detectable mesh beard snoods are available in close and extra close styles, capable of laying hair flat to effectively enclose hair whilst allowing easy breathing. Available in five easily visible colours.

**STRETCH TO FIT -  
SUITABLE FOR  
ALL BEARD  
STYLES**

**FREE SAMPLES  
AVAILABLE**

### Features & Options

25  
PACK

**METAL  
DETECTABLE**  
(by metal clip only)

AVAILABLE IN CLOSE  
AND EXTRA CLOSE MESH

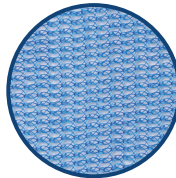
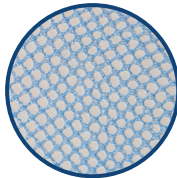

Colours:

**CLOSE  
MESH SIZE:**  
5 mm (0.19")

**EXTRA CLOSE  
MESH SIZE:**  
3 mm (0.11")



**PRODUCT CODE:** 445-T0

More product codes available – please contact us for a full price list

## Metal Detectable Non-Woven Beard Snoods

FR: Écharpes à barbe non tissées Detectanet™  
ES: Redecilla no tejida para barba Detectanet™  
DE: Detectanet™ Bartschutz aus Vliesstoff

These detectable non-woven beard snoods are capable of laying hair flat to effectively enclose hair whilst allowing the wearer to breathe easily. Available in three easily visible colours.

**EXPANDABLE  
FOR ALL  
BEARD STYLES**

### Features & Options

500  
PACK

**METAL  
DETECTABLE**  
(by aluminium foil  
strip only)

**FREE SAMPLES  
AVAILABLE**

**WEIGHT: 13G**

Colours:

**PRODUCT CODE:** 445-T013



## Metal Detectable Balaclava Hoods

FR: Cagoules Detectanet™  
 ES: Pasamontañas Detectanet™  
 DE: Detectanet™ Gesichtsmasken

Available in both reusable and disposable versions, these balaclava hoods are manufactured from a lightweight polyester non-woven fabric.

**EXPANDABLE  
 FOR ALL  
 BEARD STYLES**

**AVAILABLE IN  
 REUSABLE OR  
 DISPOSABLE  
 VERSIONS**

**WEIGHT:  
 DISPOSABLE 13G**

**100  
 PACK**

### Features & Options

**METAL  
 DETECTABLE**

(reusable - detectable by metal clip only)  
 (disposable - detectable by aluminium foil only)

Colours:  (reusable only available in white)



In Partnership  
 with  
**BROGS**

**PRODUCT CODE:** 441-TO

Sequential numbering available for all products • Ask us for a pen and knife guide

87

## Metal Detectable Mob/Bouffant Caps

FR: Charlottes Detectanet™  
 ES: Cofias Detectanet™  
 DE: Detectanet™ Netzhauben

Available in two different weights, these detectable, disposable, non-woven mob/bouffant caps offer cost effective protection for food processing environments.

**Best  
 Seller!**

**WEIGHTS:  
 STANDARD (10G)  
 PREMIUM (12G)**

**DISPOSABLE**

### Features & Options

**1000  
 PACK**

**METAL  
 DETECTABLE**

(by aluminium foil strip only)

Colours: 



**Detectanet**

**PRODUCT CODE:** 446-TO

# Metal Detectable Hairnets

FR: Filets à cheveux Detectanet™

ES: Redecillas Detectanet™

DE: Detectanet™ Haarnetze

Using “fold and hold” technology, these innovative hairnets squash the hair flat. Available in three mesh sizes for maximum hair containment.

## Features & Options

**100**  
PACK

AVAILABLE IN FINE,  
EXTRA FINE AND  
SUPER FINE MESH

**METAL**  
DETECTABLE

(by metal clip only)

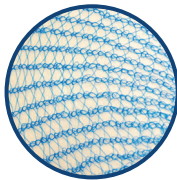

**FINE**  
MESH SIZE:  
5 mm (0.19")

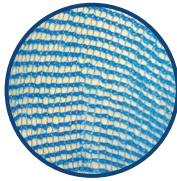

**EXTRA FINE**  
MESH SIZE:  
3 mm (0.11")



**SUPER FINE**  
MESH SIZE:  
1 mm (0.03")

**WASHABLE**  
(SUPER FINE)

**REUSABLE**



COLOURS: 

**PRODUCT CODE:** 440-T0



# Metal & X-Ray Detectable Hairnets with Neck Guard

FR: Filet à cheveux Detectamet™ avec protège-nuque

ES: Redecillas Detectamet™ con protector de cuello

DE: Detectamet™ Haarnetz mit Nackenschutz

Using “fold and hold” technology, these innovative hairnets with neck guards squash hair flat for maximum hair containment.

## Features & Options

100  
PACK



 METAL  
DETECTABLE

(by metal clip only)

TO COVER THE USER'S  
ENTIRE HAIRLINE

GUARDS FOOD FROM  
CONTAMINATION BY  
STRAY HAIR

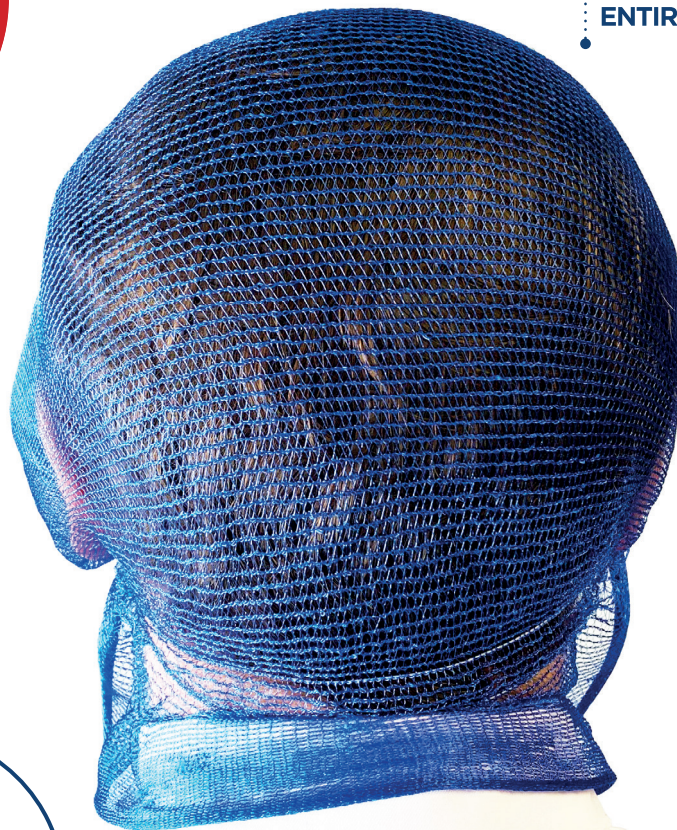

STRAP SITS  
BELOW THE  
USER'S EARS

COLOURS: 

PRODUCT CODE: 440G-T012

In Partnership  
with  
**BROS**

89

 Detectamet™



## Metal Detectable Disposable Aprons

FR: Tablier en polyéthylène

ES: Delantal de polietileno

DE: Plastik-Schürze



These fully detectable disposable aprons are suitable for additional protection over work garments and are available in blue, red, green and yellow.

### Features & Options

ROLL OF  
**100**

New  
Product!



**POLYTHENE**

**DISPOSABLE**

**SIZE:**

700 x 1250 mm (27.55 x 49.21")

**THICKNESS:**

30 micron (1.18 mils)



Colours:

**PRODUCT CODE:** 449-P0

Sequential numbering available for all products • Ask us for a pen and knife guide

## Metal Detectable Reusable Apron

FR: Tablier lavable

ES: Delantal lavable

DE: Waschbare Schürze

This detectable apron is available with/without sleeves and in two different lengths, providing additional protection for environments where there is high level soiling or water splash.

**WITH OR WITHOUT SLEEVES**

**1**  
PACK

**SIZES:**

Lengths  
1350, 1550 mm  
(53.14, 61.02")

**POLYURETHANE**

**REUSABLE**

### Features & Options

Colours:



**PRODUCT CODE:** 474-S685-

## Metal Detectable Disposable Sleeve Covers

FR: Manchons en polyéthylène

ES: Cubremangas de polietileno

DE: Plastik-Schutzärmel

These detectable blue sleeve covers are disposable and provide additional protection for environments where there is high level soiling or water splash.

### Features & Options

1000  
PACK

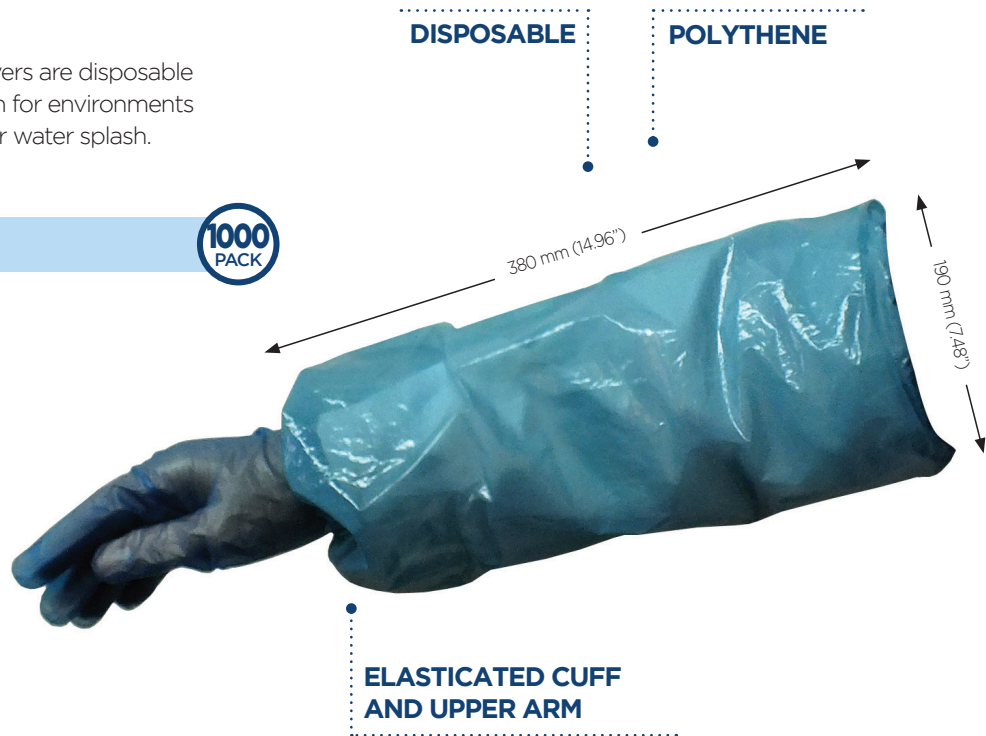

Colour:

**PRODUCT CODE:** 438-P01-X32

More product codes available – please contact us for a full price list

In Partnership  
with  
**BREGS**

91

## Metal Detectable Reusable Sleeve Covers

FR: Manchons lavables

ES: Cubremangas lavables

DE: Waschbare Schutzärmel

These detectable sleeve covers are reusable, available with two cuffing options and provide additional protection for environments where there is high level soiling or water splash.

### Features & Options

1 Pair  
PACK



Colours:

**PRODUCT CODE:** 475-S081

**Detectamet**

## Metal Detectable Shoe Covers

FR: Couvre-chaussures

ES: Cubrezapatos

DE: Schuhüberzieher

These innovative, fully detectable disposable shoe covers are durable and don't tear easily, making them ideal for visitors to food factories.

### Features & Options

**1000**  
PACK

Colour:

**DISPOSABLE**



**SIZE:**  
14 x 40 cm  
(5.51 x 15.74")

**LOW-DENSITY  
POLYETHYLENE (LDPE)**

**PRODUCT CODE:** 439-P01-X32

Sequential numbering available for all products • Ask us for a pen and knife guide

## Metal Detectable Glove Tensioners

FR: Tendeur de gant

ES: Tensor de guantes

DE: Handschuhspanner

**100**  
PACK

Disposable metal detectable glove tensioners for the meat industry, designed for a comfortable and secure fit for chain mail gloves.



### Features & Options

- Metal detectable
- Polyurethane
- Disposable

Colours:

**PRODUCT CODE:** 476-X11-

## Metal Detectable & X-Ray Visible Rubber Bands

FR: Élastiques

ES: Banditas elásticas

DE: Gummibänder

**50**  
PACK

These blue detectable rubber bands, available in three sizes, have been specifically designed for use in the food industry and are manufactured from approved food safe materials.



### Features & Options

- Metal detectable
- X-Ray visible
- Reusable
- Sizes: flat lengths 95, 110 & 125 mm (3.74, 4.33, 4.92") width 6 mm (0.23") thickness 1 mm (0.03")

Colour:

**PRODUCT CODE:** 821-S1

# Metal Detectable Litter-Free Wristband

FR: Bracelet  
ES: Pulsera  
DE: Armband



Metal detectable paper wristband, detectable with metal strip. Available in 10 colours for colour coding and traceability. Ideal for identifying factory workers, or for labelling / identifying your detectable products.

## Features & Options



INTELLIGENT LITTER-FREE DESIGN PREVENTS THE DISCARDING OF LOOSE PAPER



SEQUENTIAL NUMBERING AVAILABLE UPON REQUEST

SIZE:  
248 x 19 mm  
(9.76 x 0.74")



**PRODUCT CODE: 680-1085**

In Partnership with  
**BROGS**

93





## Metal Detectable and X-Ray Visible Lightweight Safety Glasses

FR: Lunettes de sécurité légères

ES: Gafas protectoras livianas

DE: Leichte schutzbrille

1  
PACK

These lightweight safety glasses have detectable arms, making them perfect for use in the food and pharmaceutical industries, and are suitable for continuous use.



COMPATIBLE  
WITH GLASSES  
CORD

### Features & Options

- Metal detectable
- X-Ray visible
- A Blue 80% VLT 'indoor tint' lens with anti-fog lens coating for long lasting durability
- Polycarbonate lenses absorb 99.9% of harmful UV A, B and C, 180-380nm
- Weight: 18g (0.63oz)

Colour:

**PRODUCT CODE:** 421-T545

## Metal Detectable and X-Ray Visible Ultra Lightweight Safety Glasses

FR: Lunettes de sécurité ultra-légères

ES: Gafas protectoras ultralivianas

DE: Ultraleichte schutzbrille

1  
PACK

These ultra lightweight safety glasses have detectable arms, making them perfect for use in the food and pharmaceutical industries, and are suitable for continuous use.



COMPATIBLE  
WITH GLASSES  
CORD

### Features & Options

- Metal detectable
- X-Ray visible
- A Blue 80% VLT 'indoor tint' lens with anti-fog lens coating for long lasting durability
- Polycarbonate lenses absorb 99.9% of harmful UV A, B and C, 180-380nm
- Weight: 15g (0.53oz)

Colour:

**PRODUCT CODE:** 421-T546

More product codes available – please contact us for a full price list

## Metal Detectable and X-Ray Visible Lightweight Over Glasses

FR: Surlunettes légères

ES: Gafas extralivianas

DE: Leichte schutzbrille für Brillenträger

1  
PACK

These lightweight over glasses can fit over frames up to 140mm (5 1/2") wide and have detectable arms, making them perfect for use in the food and pharmaceutical industries. They are suitable for continuous use.



### Features & Options

- Metal detectable
- X-Ray visible
- Fits over medium sized prescription eyewear up to 144mm (5 1/2") wide
- Weight: 28g (1oz)
- A Blue 80% VLT 'indoor tint' lens with anti-fog lens coating for long lasting durability
- Polycarbonate lenses absorb 99.9% of harmful UV A, B and C, 180-380nm

Colour:

**PRODUCT CODE:** 421-T547

## Metal Detectable Glasses Cord

FR: Cordon à lunettes

ES: Cuerda para gafas

DE: Sicherheitsband für Brille

25  
PACK

Metal detectable glasses cord in silicone. Keeps glasses safely secured around the wearer's neck.



### Features & Options

- Metal Detectable
- Reusable
- Flexible silicone affixes to most reading & safety glasses

Colour:

**Made In:**  
**UK**

**PRODUCT CODE:** 466-P75-X06 - Silicone

# Detectamet Offer **Own Branding & Sequential Numbering**

**Perfect for knives and other products, sequential numbering is done in-house on our laser engraving machine.**

Sequential numbering gives you complete traceability and is particularly important if production presents higher risks, making it even more important to eliminate any type of contamination.

Our cost effective laser engraving service adds sequential numbers onto your products.

**How about branding your detectable products using our cost effective pad printer?**

Pad printing offers superior quality one and two colour print on 3D irregular, curved and textured objects, making it perfect for our products.

**Where pad printing and laser engraving are not appropriate - due to the product - we can print your logos at point of manufacture, e.g. keyhole tags, test pieces. Ask a member of our team for advice.**

**Can't see what you're looking for?**

**Or are you looking for a detectable product for a specific project or application?**

**Don't worry!** We're always happy to talk about bespoke products and will always try our best to find a solution.



# Metal Detectable Utility Clips

FR: Clip pratique détectable

ES: Broche detectable de uso general

DE: Detektierbare Klammer

These blue, detectable utility clips are available with one or two clips, perfect for keeping gloves, keys and swipe cards etc. close to hand.

## Features & Options

10  
PACK

In Partnership  
with  
**BRCS**

96

**etectamet**

MANUFACTURED  
FROM PLASTIC  
WITH DETECTABLE  
ADDITIVE

ATTACHES TO BELT  
FOR EASY ACCESS

AVAILABLE WITH  
SINGLE CLIP AND  
BELT ATTACHMENT  
OR DUAL CLIPS

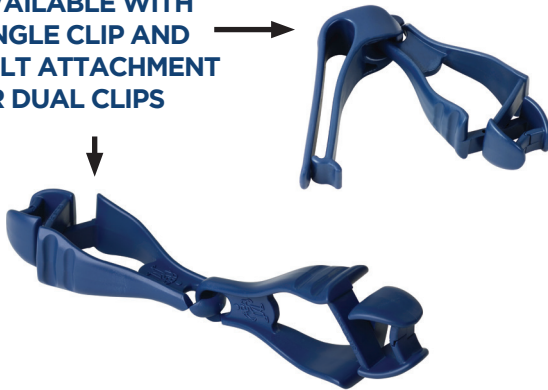

BREAKAWAY  
SAFETY FEATURE



SLOTTED CLIP MOUNTS  
TO BELT OR POCKET CLIPS

Colour: 

PRODUCT CODE: 469-A95 WITH DUAL CLIP / 469-A96 WITH BELT CLIP



## Metal Detectable Silicone Reusable Ear Savers

FR: Economiseur d'oreille

ES: Protector de oreja

DE: Ohrensparer

Our ergonomic silicone ear savers are made from flexible, metal detectable silicone rubber. They can comfortably support a reusable or non-reusable face mask. They're also notched to allow the face mask to be fully adjustable for further comfort.

**New Product!**

**Made In:**  
UK   
USA 

**SIZES:**

Lengths: 99 mm (3.89") x 26 mm (1.02") (pictured)  
or  
141 mm (5.55") x 26 mm (1.02")

**SILICONE RUBBER COMFORTABLY WRAPS ROUND USER'S HEAD**

**Features & Options**

**10 PACK**

Colour: 

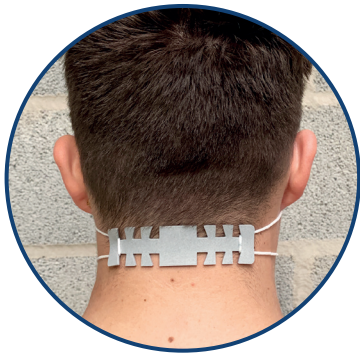

**FITS REUSABLE AND DISPOSABLE FACE MASKS**

**ADJUSTABLE SETTINGS FOR COMFORT**

**PRODUCT CODE:** 477S

Sequential numbering available for all products • Ask us for a pen and knife guide

In Partnership with  
**BROGS**

**97**

## Metal Detectable and X-Ray Visible Plastic Reusable Ear Savers

FR: Economiseur d'oreille

ES: Protector de oreja

DE: Ohrensparer

Our reusable metal and X-ray detectable Ear Savers allow the user to adjust their face mask to a comfortable fit and saves users from wrapping the face masks around their ears which, after time, can cause discomfort.

**New Product!**

**Made In:**  
UK 

**Best Seller!**

**Features & Options**

**10 PACK**

Colours: 

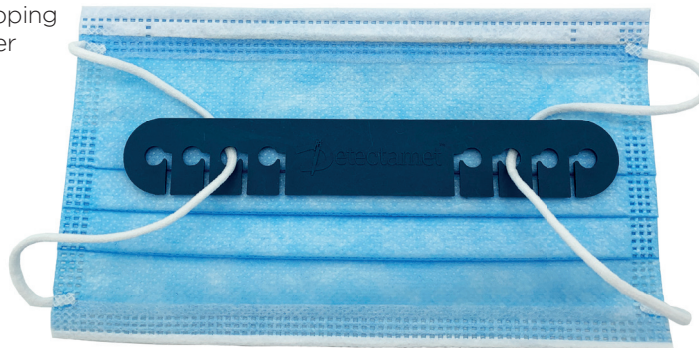

**FITS REUSABLE AND DISPOSABLE FACE MASKS**

**ADJUSTABLE SETTINGS FOR COMFORT**

**SIZE:**  
141 mm (5.55") x 22 mm (1.08")

**PRODUCT CODE:** 477-P0

**detectamet**



# Metal & X-Ray Detectable Face Mask Spacer / Bracket

FR: Entretoise de masque facial

ES: Espaciador de mascarilla

DE: Gesichtsmaske Abstandhalter

Designed to fit inside a face mask / covering, our face mask brackets provide added comfort by keeping face masks away from the user's mouth. Manufactured from Detectamet's market leading EU & FDA food contact approved metal and X-ray detectable polypropylene, these face mask spacers are lightweight and washable for reuse.

In Partnership with  
**BROS**

98

**D**etectamet

## Features & Options

**1**  
PACK



FIXES TO THE  
INSIDE OF A  
FACE MASK /  
COVERING

Colours:

**SIZE:**  
105 x 90 x 42 mm  
(4.13 x 3.54 x 1.65")

**PRODUCT CODE:** 470B

# Metal Detectable Face Coverings

FR: Masque

ES: Mascarilla

DE: Schutzmaske

Metal detectable face mask, detectable by aluminium foil strip. Ideal for use in food industry production areas.

Please note that this product does not have a certified bacterial filtration efficiency rating. This product should not be considered to be a medical device or classed as PPE.

## Features & Options

**50  
PACK**

**New  
Product!**



**METAL DETECTABLE BY  
ALUMINIUM FOIL STRIP**

**FITTED FACE COVERING WITH  
GUSSETS TO EXPAND SIZE**

**CONSISTS OF 3 LAYERS OF  
MATERIAL**

**FITTED WITH WIRE TO GIVE  
SHAPE AROUND USER'S FACE**

**AVAILABLE IN 8 COLOURS FOR  
ADDED TRACEABILITY**



Colours: 

**PRODUCT CODE: 470**

In Partnership  
with  
**BREGS**

**99**

**etectamet**

# Metal & X-Ray Detectable Face Mask / Covering Dispenser

**Best Seller!**



FR: Distributeur de masque facial  
 ES: Dispensador de mascarilla  
 DE: Gesichtsmasken-Spender

Keep your face masks organised and accessible with our metal and X-ray detectable wall-mountable face mask dispensers. Suitable for conventional face masks, these dispensers keep your face masks in a neat pile, making them easy to grab and go. Available in 9 colour options or stainless steel.

## Features & Options

**1**  
PACK

### Plastic Dispenser

**New Products!**

### Steel Dispenser



WALL MOUNTABLE WITH TWO PRE-DRILLED 6MM (0.23") HOLES

SUITABLE FOR LASER ENGRAVING

WALL MOUNTABLE WITH TWO PRE-DRILLED 6MM (0.23") HOLES



NEW 2021 INTERLOCKING DESIGN

SIZE:  
210 x 105 x 202 mm  
(8.26 x 4.13 x 7.95")

Colours:

Colour:

PRODUCT CODE: 460D

In Partnership with  
**BRCGS**

100

**Detectamet**



# Metal & X-Ray Detectable Stainless Steel Multi-Purpose Dispenser - Single or Double

FR: Distributeur multi-usage en acier inoxydable

ES: Expendedor multifunción de acero inoxidable

DE: Mehrzweckspender aus Edelstahl

This stainless steel, detectable dispenser is wall mountable or free standing and is suitable for dispensing a wide range of PPE, keeping your processing area tidy. Available as a single or double divider.

**1**  
PACK

## Features & Options

### Single Dispenser

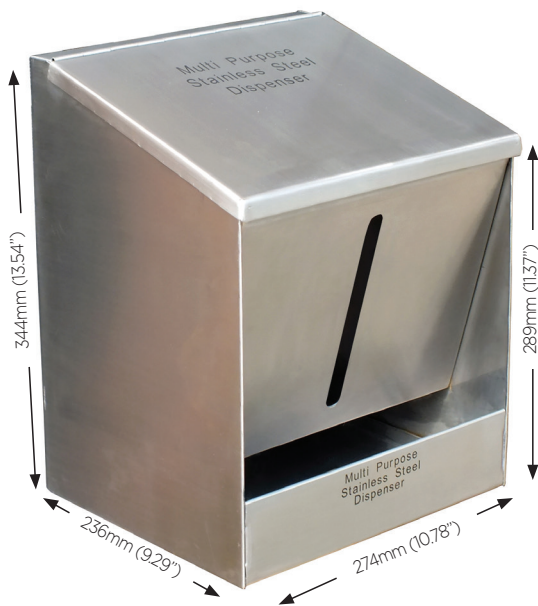

### Double Dispenser



SUITABLE  
FOR LASER  
ENGRAVING

WALL MOUNTABLE  
OR FREE STANDING



Colour:

#### SIZES (BOTH DISPENSERS):

274 x 236 x 344 sloping to 289 mm  
(10.78 x 9.29 x 13.54 sloping to 11.37")

**PRODUCT CODE: 453-P45**

In Partnership  
with

**BROGS**

101

**Detectamet**



# Metal Detectable & X-Ray Visible Storage, Mixing & Handling

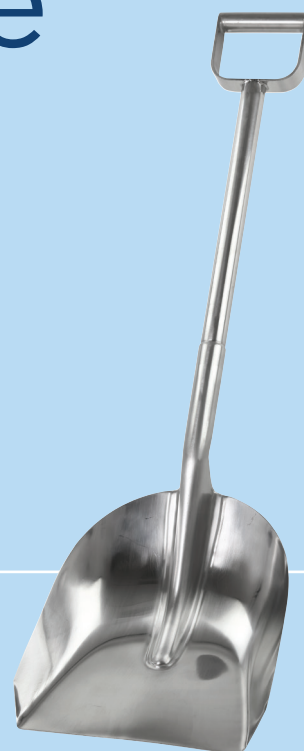

**FR:** Stockage, mélange et manutention

**ES:** Almacenamiento, mezcla y manipulación

**DE:** Aufbewahrung, Mischen und Transport

102

Utility Hook	104	Shelf	124	Stainless Steel Paddles & Forks	138
Flexible or Rigid Scraper	105	Sanitiser Bottle Holder	125	Stainless Steel Scoops	139
Flexible Scrapers	106	Plastic/Steel Paper Towel Holder	125	Stainless Steel Pharma Scoops	139
Serrated Edge Flexible Scrapers	106	Shovel	126	Stainless Steel Pails	140
Mini Spatulas	107	Paddle without Holes	127	Stainless Steel Bucket with Lid	141
Gasket Scraper & Dough Cutter	107	Large Paddle	127	Stainless Steel Whisk & Bowl	141
Scraper with Stainless Steel or Brass Blade	108	Scouring Pad & Spray Bottle	128	Stainless Steel Measuring Jug	142
Hand Scrapers	109	Resin-Set Brushes	129	Stainless Steel Funnel	142
Bench Scraper & Small Scraper	110	Resin-Set Hand Brush with	129	Tote Bin Cover Dispenser	143
Stirrer/Scraper	110	Medium Bristles		Tote Bin Covers	144
Square Scoops	111	Resin-Set Long Handled Brush	130	Extra Large Tote Bin Covers	145
Round Bowl Scoops	112	Resin-Set Hand Brush with	130	Polythene Bags & Liners	146
Flour Scoops	113	Stiff Bristles		Pallet Band	147
Pouring Jug & Scooping Jug	114	Resin-Set Nail Brush	130	Bag Grippers	147
Jug with Lid	115	Brushes & Brooms	131	Bag Closure Grips	147
Measuring Cups & Measuring Spoons	115	Hand Brush	131		
Sampling Cutlery & Sampling Cups	115	Hand Brush with Long Handle	132		
Sampling Beakers	116	Nail Brush	132		
Prover Pocket	116	Cylinder Brush	132		
Bucket with Lid	116	Cylinder Brush for Long Handle	133		
Bucket without Handle	117	Round Hand Brush	133		
Storage Box & Containers	117	Large Hand Brush	133		
Disinfectant Wipe Dispenser	118	Short Handled Brush	133		
Dustpan	118	Dish Brush & Floor Brush	134		
Storage Tray with Lid	120	Push Broom	134		
Double Sided Tape	121	Tabletop Squeegee	134		
Detectortape	121	Floor Squeegee & Floor Scraper	135		
Disinfectant & Probe Wipe Dispenser Holder	122	Handles	135		
Trigger Sprayer & Wipe Dispenser Holder	123	Health & Safety Signs & Floor Stickers	136		
		Floor Signs	137		
		Stainless Steel Shovels and Spades	138		

# Bespoke Shadow & Management Boards

FR: Panneau porte-outil  
ES: Tablero de herramientas  
DE: Shadow Board

Take a look at our Shadow Board double-page spread - **pages 158 & 159!**

**Made In:**  
**UK** 



In Partnership with  
**BROGS**

103

Management tool for clear team communication and organisation. Ideal for safe and efficient tool storage and incorporates Kaizen and 5S principles to assist with food safety management audits.

## Features & Options

**BESPOKE SIZES AVAILABLE**

**REDUCES RISK OF CROSS CONTAMINATION**

**QUICKLY IDENTIFY MISSING ITEMS**

**COMPLETELY CUSTOMISABLE**

**SUPPLIED WITH STAINLESS STEEL OR DETECTABLE PLASTIC FITTINGS. PURPOSE BUILT HOLDERS FOR HANGING & SECURING TOOLS**

**SOLD INDIVIDUALLY**

Supplied with a great range of shadow board accessories!



Hook Colours: 

**PRODUCT CODE: 931**

**detectamet**

# Metal & X-Ray Detectable Utility Hook

FR: Crochet

ES: Gancho

DE: Haken



Multi purpose wall mountable utility hook, available in 9 colours and 2 sizes.

## Features & Options



AVAILABLE AS SINGLE OR DOUBLE HOOKS

SUITABLE FOR PAD PRINTING/LASER ENGRAVING

### Features & Options

- Metal detectable
- X-Ray visible
- Manufactured from EU & FDA food contact approved detectable polymer

Sizes:

- Small - 42 mm width x 78 mm height x 66 mm depth (1.65" x 3.07" x 2.59")
- Large - 60 mm width x 109 mm height x 95 mm depth (2.36" x 4.29" x 3.74")



AVAILABLE IN 2 SIZES



PRODUCT CODE: 136

In Partnership with  
**BRGS**

104

**Detectamet**

# Metal & X-Ray Detectable Flexible or Rigid Scraper with Stainless Steel Blade

FR: Grattoir à poignée en plastique

ES: Rasqueta con mango de plástico

DE: Schaber mit Plastikgriff



Available with either a rigid or flexi stainless steel blade, the plastic grip handle of this scraper is fully detectable.

## Features & Options



SUITABLE FOR PAD  
PRINTING/LASER  
ENGRAVING

### Features & Options

- Metal detectable
- X-Ray visible
- Stainless steel blade with fully detectable handle
- Suitable for pad printing/laser engraving
- Manufactured from EU & FDA food contact approved detectable polymer

### Sizes:

- flexi: 120 x 100 mm (4.72 x 3.93")
- rigid: 150mm x 125 mm (5.90 x 125")

### Blade Thicknesses:

- flexi: 0.29 mm (11.41 mils)
- rigid: 0.87 mm (34.25 mils)

STAINLESS STEEL  
BLADE



In Partnership  
with  
**BROS**

105

**Detectamet**

PRODUCT CODE: 522-T09



## Metal Detectable & X-Ray Visible Flexible Scrapers

FR: Grattoirs flexibles  
 ES: Rasquetas flexibles  
 DE: Flexible Schaber



MANUFACTURED FROM EU & FDA FOOD CONTACT APPROVED DETECTABLE POLYMER

KEY HOLE FOR ATTACHING CHAIN

These detectable flexible scrapers are available in two sizes and nine colours. Made from very durable, food safe polypropylene and nylon, they are suitable for a wide range of food uses.

### Features & Options

5 PACK



SUITABLE FOR PAD PRINTING/LASER ENGRAVING

**THICKNESSES:**  
 small: 1.89 mm (74.40 mils)  
 large: 1.89 mm (74.40 mils)

**SIZE:**  
 small: 160 x 103 mm (6.29 x 4.05")  
 large: 225 x 118 mm (8.85 x 4.64")



Colours:

**PRODUCT CODE:** 523-S

Sequential numbering available for all products • Ask us for a pen and knife guide

## Metal Detectable & X-Ray Visible Serrated Edged Flexible Scrapers

FR: Grattoirs flexibles à bord cranté  
 ES: Rasquetas flexibles con bordes dentados  
 DE: Flexible Schaber mit Wellenprofil

MANUFACTURED FROM EU & FDA FOOD CONTACT APPROVED DETECTABLE POLYMER



KEY HOLE FOR ATTACHING CHAIN

These detectable flexible scrapers have a serrated edge for creating a textured finish, and are available in two sizes and nine colours.

### Features & Options

5 PACK

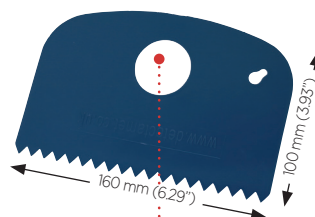

THUMB HOLE

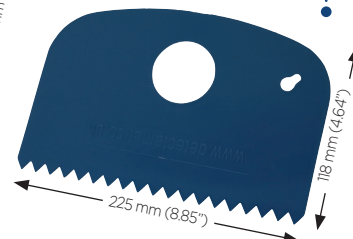

SUITABLE FOR PAD PRINTING/LASER ENGRAVING

**SIZE:**  
 small: 160 x 100 mm (6.29 x 3.93")  
 large: 225 x 118 mm (8.85 x 4.64")

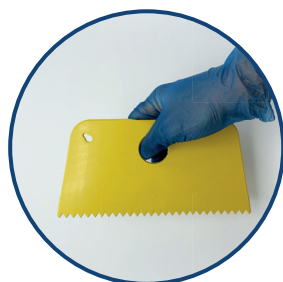

Colours:

**PRODUCT CODE:** 523-S0

## Metal Detectable & X-Ray Visible Mini Spatulas

FR: Spatule  
 ES: Espátula  
 DE: Spachtel

10  
PACK

These miniature, detectable spatulas are made from very durable and food safe polypropylene and are suitable for a range of food uses.



### Features & Options

- Metal detectable
- X-Ray visible
- Length: 160 mm (6.29")
- Blade width: 17 mm (0.66")
- Manufactured from EU & FDA food contact approved detectable polymer

Colour:

**PRODUCT CODE:** 518-S261-P01

## Metal Detectable & X-Ray Visible Gasket Scraper with Stainless Steel Blade

FR: Grattoir à joint à poignée en plastique  
 ES: Rasqueta para juntas con mango de plástico  
 DE: Dichtungsschaber mit Plastikgriff

Made In:  
UK

1  
PACK

This gasket scraper is available in three different width blades and has a fully detectable handle with a stainless steel blade.

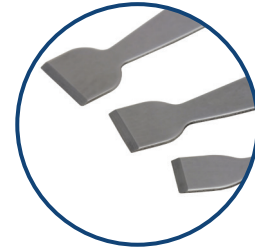

### Features & Options

- Metal detectable
- X-Ray visible
- Stainless steel blade with fully detectable handle
- Blade sizes: 12, 16, 20 mm (0.47, 0.62, 0.78")
- Suitable for pad printing/laser engraving
- Manufactured from EU & FDA food contact approved detectable polymer

Handle: Blade:

**PRODUCT CODE:** 586-W

In Partnership with  
**BREGS**

More product codes available – please contact us for a full price list

107

## Metal Detectable & X-Ray Visible Dough Cutter

FR: Coupeuse de pâte en acier inoxydable  
 ES: Cortador de masa de acero inoxidable  
 DE: Teigmesser aus Edelstahl

1  
PACK

This 304 stainless steel dough cutter has a metric and imperial rule marked on the blade.

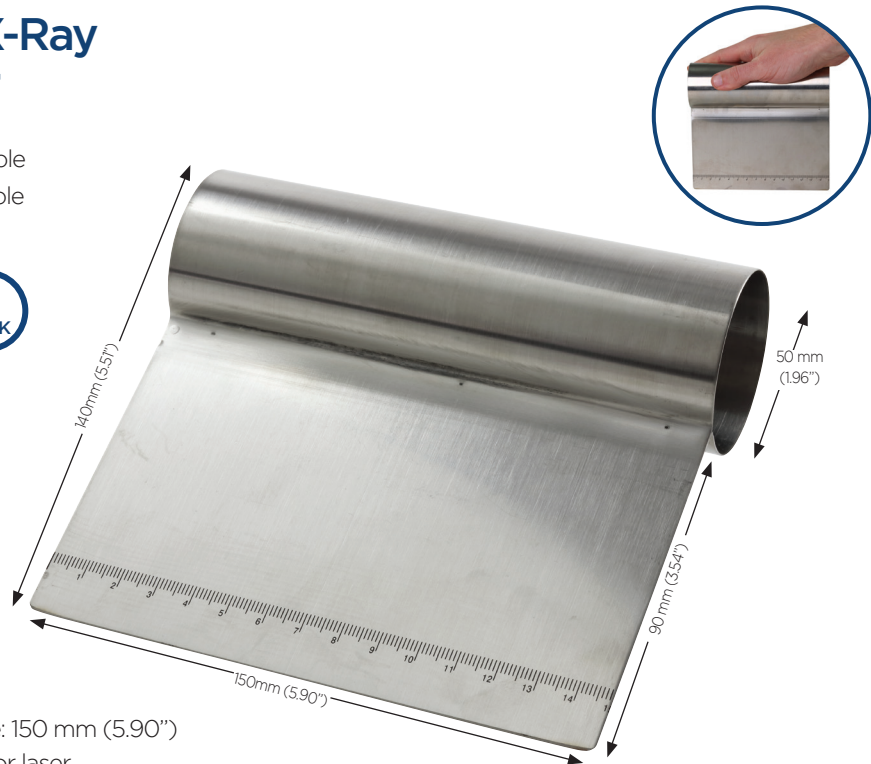

### Features & Options

- Metal detectable
- X-Ray visible
- Metric/imperial rule marked on blade
- Blade size: 150 mm (5.90")
- Suitable for laser engraving

Colour:

**PRODUCT CODE:** 519-P32-T160

**detectamet**

# Metal & X-Ray Detectable Scraper with Stainless Steel or Brass Blade

FR: Grattoirs en acier inoxydable, aluminium et laiton

ES: Rasquetas de acero inoxidable, aluminio y latón

DE: Schaber aus Edelstahl, Aluminium und Messing

Available with either a stainless steel or brass blade, in three different blade widths.  
Handles are available in aluminium, stainless steel or detectable plastic.

## Features & Options

**10  
PACK**



SUITABLE FOR PAD  
PRINTING/LASER  
ENGRAVING

HANDLES AVAILABLE  
IN ALUMINIUM,  
STAINLESS STEEL OR  
DETECTABLE PLASTIC



STAINLESS STEEL  
OR BRASS BLADE

BLADE SIZES:

38, 50, 75 mm (1.49, 1.96, 2.95")

Handle Colours:



Blade Colours:



PRODUCT CODE: 586-W

# Metal & X-Ray Detectable Hand Scrapers

FR: Grattoir à main  
ES: Rasqueta de mano  
DE: Handschaber



These fully detectable hand scrapers are available in nine different colours and two blade sizes.

## Features & Options



SUITABLE FOR PAD  
PRINTING/LASER  
ENGRAVING

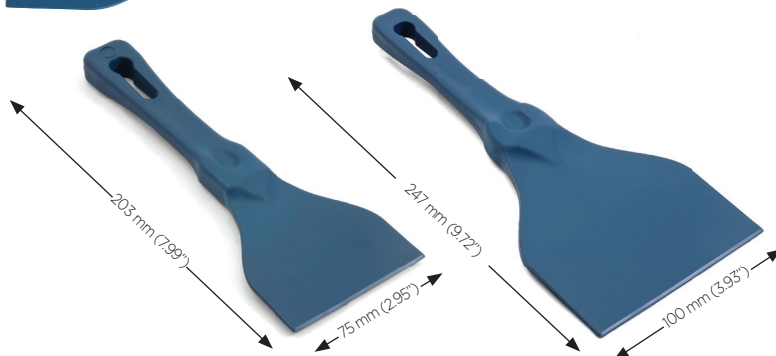

MANUFACTURED FROM  
EU & FDA FOOD CONTACT  
APPROVED DETECTABLE  
POLYMER

### SIZES:

small: 75 x 203 mm (2.95 x 7.99")  
large: 100 x 247 mm (3.93 x 9.72")

Colours:

PRODUCT CODE: 523-S1

In Partnership  
with

**BREGS**

109

**detectamet**



## Metal Detectable & X-Ray Visible Bench Scraper

**FR:** Racleurs de banc de travail à code couleur  
**ES:** Rasquetas de mesa codificadas por color  
**DE:** Teigschaber mit Farbkodierung



This fully detectable bench scraper is available in five colours and has an ergonomically designed handle.

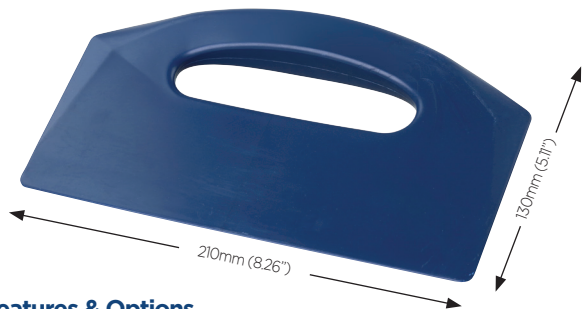

### Features & Options

- Metal detectable
- X-Ray visible
- Ergonomic handle
- Size: 210 x 130 mm (8.26" x 5.11")
- Manufactured from EU & FDA food contact approved detectable polymer



Colours:

**PRODUCT CODE:** 523-S240

## Metal Detectable & X-Ray Visible Small Scraper

**FR:** couteau à palette flexible  
**ES:** Chuchillo espátula flexible  
**DE:** Flexibles palettenmesser



This small flexible scraper is designed to spread and smooth soft mixtures.

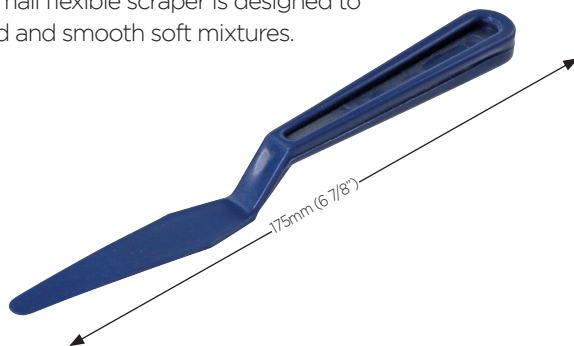

### Features & Options

- Metal detectable
- X-Ray visible
- Flexible
- Blade size: 76mm (3")
- Length: 175mm (6 7/8")
- Manufactured from EU & FDA food contact approved detectable polymer

Colour:

**PRODUCT CODE:** 521-T102-P01

Sequential numbering available for all products • Ask us for a pen and knife guide

## Metal Detectable & X-Ray Visible Stirrer/Scraper

**FR:** Agitateurs et grattoirs  
**ES:** Agitadores y rasquetas  
**DE:** Rührstäbchen und Schaber

This stirrer/scraper is available in nine different colours, with or without holes, making it suitable for mixing ingredients or scraping products from small areas.

### Features & Options



### Features & Options

- Metal detectable
- X-Ray visible
- Solid blade
- With or without holes
- Size: 260 x 40mm (10.23 x 1.57")
- Suitable for pad printing/laser engraving
- Manufactured from EU & FDA food contact approved detectable polymer

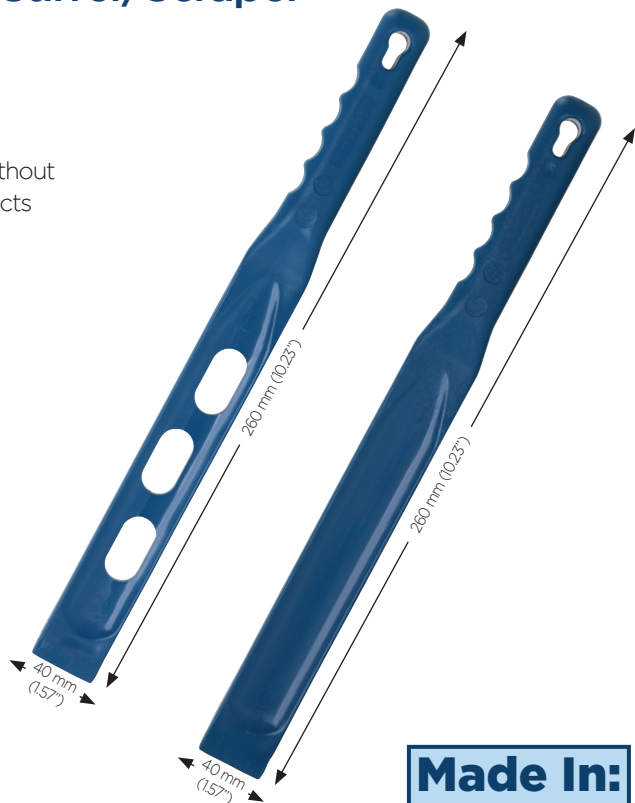

Colours:

**PRODUCT CODE:** 517-A5

# Metal & X-Ray Detectable Square Scoops

FR: Pelles carrées

ES: Cucharones cuadrados

DE: Vierkantige Schaufeln



These square scoops come in four different sizes and nine different colours, making them ideal for a wide range of ingredients and process areas.

## Features & Options



SUITABLE FOR LASER ENGRAVING

MANUFACTURED FROM EU & FDA FOOD CONTACT APPROVED DETECTABLE POLYMER

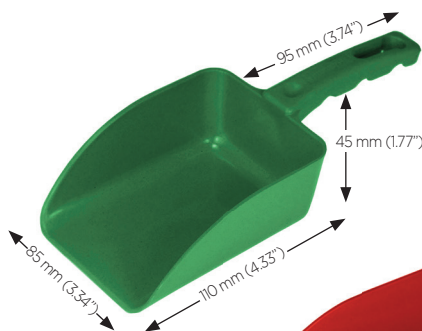

MINI SCOOP

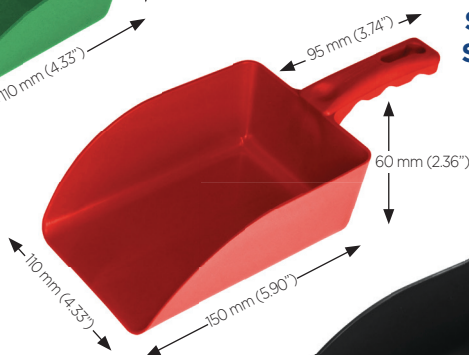

SMALL SCOOP

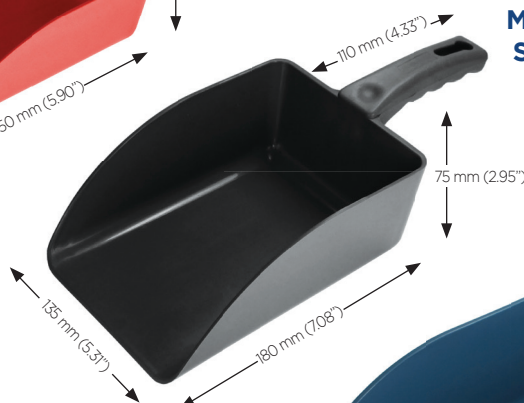

MEDIUM SCOOP

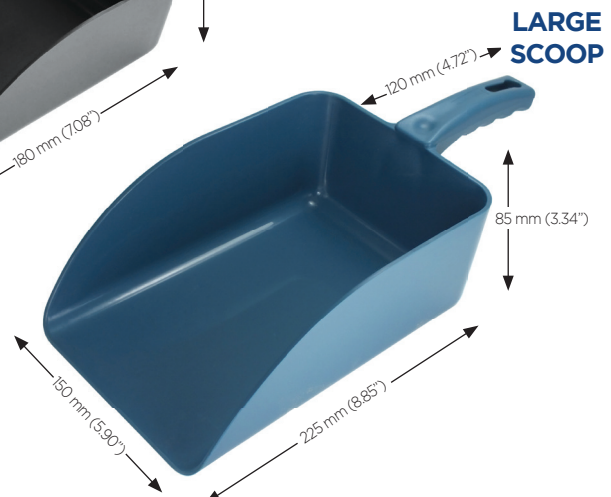

LARGE SCOOP

### CAPACITIES:

mini: 100 ml (3.51 fl oz)

small: 350 ml (11.83 fl oz)

medium: 800 ml (27.05 fl oz)

large: 1250 ml (42.26 fl oz)

### SIZES:

mini: 110 x 85 x 45 mm (4.33 x 3.34 x 1.77")  
handle length 95 mm (3.74")

small: 150 x 110 x 60 mm (5.90 x 4.33 x 2.36")  
handle length 95 mm (3.74")

medium: 180 x 135 x 75 mm (7.08 x 5.31 x 2.95")  
handle length 110 mm (4.33")

large: 225 x 150 x 85 mm (8.85 x 5.90 x 3.34")  
handle length 120 mm (4.72")



PRODUCT CODE: 514-S0

In Partnership with

**BROGS**

111

**Detectamet**

# Metal & X-Ray Detectable Round Bowl Scoops

FR: Pelles rondes

ES: Cucharones redondos

DE: Abgerundete Schaufeln



These round scoops have two pouring spouts, making them ideal for both liquids and solids. Available in nine colours.

## Features & Options



METRIC/IMPERIAL GRADUATION MARKS INSIDE



CAPACITY:  
1000 ml (33.81 fl oz)



SIZE:  
dia. 215 mm (8.46") depth 70 mm (2.75")  
handle length 145 mm (5.70")

MANUFACTURED FROM EU & FDA FOOD CONTACT APPROVED DETECTABLE POLYMER

SUITABLE FOR PAD PRINTING/LASER ENGRAVING

ROUND SCOOP

Colours:

PRODUCT CODE: 514-S240

In Partnership with  
**BRGS**

112

etectamet

# Metal & X-Ray Detectable Flour Scoops

FR: Pelles à farine

ES: Cucharones para harina

DE: Mehl-Schaufeln



These flour scoops come in three different sizes and are available in three colours.

## Features & Options



**METRIC/IMPERIAL  
GRADUATION  
MARKS INSIDE**



**MANUFACTURED  
FROM EU & FDA FOOD  
CONTACT APPROVED  
DETECTABLE  
POLYMER**



**SUITABLE FOR PAD  
PRINTING/LASER  
ENGRAVING**

### SIZES:

155 x 50 x 40 mm (6.10 x 1.96 x 1.57")  
handle length 90 mm (3.54")  
195 x 60 x 50 mm (7.67 x 2.36 x 1.96")  
handle length 100 mm (3.93")  
245 x 75 x 60 mm (9.64 x 2.95 x 2.36")  
handle length 110 mm (4.33")

### CAPACITIES:

small: 250 ml (8.45 fl oz)  
medium: 500 ml (16.90 fl oz)  
large: 1000 ml (33.81 fl oz)

Colours:

**PRODUCT CODE: 515-S0**

In Partnership  
with

**BROS**

113

**Detectamet**



## Metal Detectable & X-Ray Visible Stackable Pouring Jug

FR: Verres doseurs empilables  
 ES: Jarras para verter apilables  
 DE: Stapelbare henkelkrüge zum gießen

This stackable pouring jug comes in two sizes and nine different colours and is manufactured from EU and FDA food contact approved detectable polymer.

### Features & Options

1  
PACK

STACKABLE



Colours:

MANUFACTURED FROM EU & FDA FOOD CONTACT APPROVED DETECTABLE POLYMER

METRIC/IMPERIAL MEASUREMENTS INSIDE



Made In: UK

SUITABLE FOR PAD PRINTING/LASER ENGRAVING

### SIZES & CAPACITIES:

small 1000 ml (33.81 fl oz)  
 height 120 mm (4.72")  
 dia. 115 mm (4.52")  
 large 2000 ml (67.62 fl oz)  
 height 157 mm (6.18")  
 dia. 145 mm (5.70")

PRODUCT CODE: 535-S012

Sequential numbering available for all products • Ask us for a pen and knife guide

## Metal Detectable & X-Ray Visible Stackable Scooping Jug

FR: Verres doseurs empilables avec bec verseur  
 ES: Jarras para recoger apilables  
 DE: Stapelbare henkelkrüge zum schöpfen

This stackable scooping jug comes in nine different colours and is manufactured from EU and FDA food contact approved detectable polymer.

### Features & Options

1  
PACK

STACKABLE



Colours:

MANUFACTURED FROM EU & FDA FOOD CONTACT APPROVED DETECTABLE POLYMER

METRIC/IMPERIAL MEASUREMENTS INSIDE



Made In: UK

SUITABLE FOR PAD PRINTING/LASER ENGRAVING

### SIZE & CAPACITY:

2000 ml (67.62 fl oz)  
 height 175 mm (6.88")  
 width (widest part) 170 mm (6.69")

PRODUCT CODE: 535-S018

## Metal Detectable & X-Ray Visible Jug with Lid

FR: Pichets à couvercle

ES: Jarras con tapa

DE: Henkelkrüge mit Deckel

1  
PACK

Available in blue, this one litre jug has a removable lid and measurements inside.



### Features & Options

- Metal detectable
- X-Ray visible
- Stackable
- Metric/imperial graduation marks on inside
- Size: 1000 ml (33.81 fl oz / 1.75 pt)
- Suitable for pad printing

Colour: ■

Made In:  
UK

PRODUCT CODE: 536-P01

## Metal Detectable & X-Ray Visible Measuring Cups

FR: Cups de mesure

ES: Tazas de medición

DE: Messbecher

5  
PACK

These fully detectable, four piece measuring cups are perfect for measuring small quantities and are manufactured from EU and FDA food contact approved detectable polymer.



### Features & Options

- Metal detectable
- X-Ray visible
- Manufactured from EU and FDA food contact approved detectable polymer
- Adjoined four-piece set
- Metric/imperial sizes on handles
- Sizes:
  - 1/4 cup 60 ml (2 fl oz)
  - 1/3 cup 80 ml (3 fl oz)
  - 1/2 cup 125 ml (4 fl oz)
  - 1 cup 250 ml (9 fl oz)
- Suitable for pad printing

Colour: ■

Made In:  
UK

PRODUCT CODE: 542-T184-S635-P01

More product codes available – please contact us for a full price list

## Metal Detectable & X-Ray Visible Measuring Spoons

FR: Cuillères doseuses

ES: Cucharas de medición

DE: Messlöffel

5  
PACK

These fully detectable, four piece measuring spoons are perfect for measuring small quantities and are manufactured from EU and FDA food contact approved detectable polymer.



### Features & Options

- Metal detectable
- X-Ray visible
- Manufactured from EU and FDA food contact approved detectable polymer
- Adjoined four-piece set
- Metric/imperial sizes on handles
- Sizes:
  - 2.5ml (1/2 tsp), 5ml (1 tsp), 10ml (1 dsp), 15ml (1 tbsp)
- Suitable for pad printing

Colour: ■

Made In:  
UK

PRODUCT CODE: 541-T184-S634-P01

## Metal Detectable & X-Ray Visible Sampling Cutlery

FR: Couteaux, fourchettes et cuillers d'échantillonnage

ES: Cuchillos, tenedores y cucharas para muestras

DE: Probemesser, -gabeln und -löffel

10  
PACK

Detectable reusable cutlery suitable for sampling.



### Features & Options

- Metal detectable
- X-Ray visible
- Manufactured from EU and FDA food contact approved detectable polymer
- Reusable
- Suitable for pad printing

Colour: ■

Made In:  
UK

PRODUCT CODE: 527-P01, 529-P01, 531-P01

## Metal Detectable & X-Ray Visible Sampling Cups

**FR:** Gobeletes doseurs  
**ES:** Tazas para muestras  
**DE:** Proben tasse

**10**  
PACK

These detectable sampling cups are available in two sizes, manufactured from EU and FDA food contact approved detectable polymer and will easily withstand regular autoclaving.



### Features & Options

- Metal detectable
- X-Ray visible
- Manufactured from EU and FDA food contact approved detectable polymer
- Reusable
- Capacities: 284 ml (1/2pt), 568 ml (1pt)
- Suitable for pad printing

**Made In:**  
UK

**Colour:**

**PRODUCT CODE:** 502-T208, 502-T444

## Metal Detectable & X-Ray Visible Sampling Beakers

**FR:** Coupes et béchers de prélèvement  
**ES:** Vasos y vasos de precipitados para muestras  
**DE:** Probetassen und -becher

**10**  
PACK

These detectable sampling beakers are manufactured from EU and FDA food contact approved detectable polymer and will easily withstand regular autoclaving.



### Features & Options

- Metal detectable
- X-Ray visible
- Manufactured from EU and FDA food contact approved detectable polymer
- Reusable
- Capacity: 284ml (1/2pt)
- Suitable for pad printing

**Made In:**  
UK

**Colour:**

**PRODUCT CODE:** 502-T200

Sequential numbering available for all products • Ask us for a pen and knife guide

## Partially Metal Detectable & X-Ray Visible Prover Pocket

**FR:** Poches de fermentation  
**ES:** Cuenco de malla para leudar masa  
**DE:** Teigmulden

**1**  
PACK

This blue prover pocket has a fully detectable frame and is made from food safe, approved materials, making it perfect for proving and shaping dough.

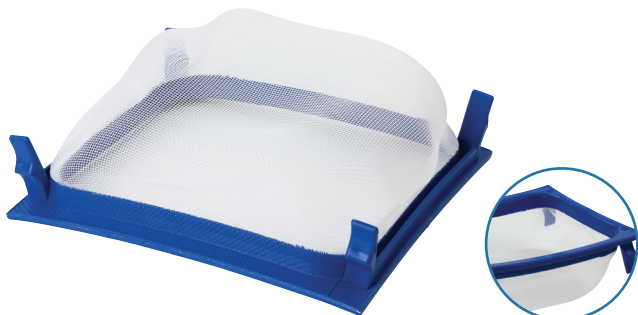

### Features & Options

- Partially metal detectable (by frame)
- Partially X-Ray visible (by frame)
- Frame securely fixed to mesh
- Size: 168 x 187 x 85 mm (6.61 x 7.36 x 3.34")

**Colour:**

**PRODUCT CODE:** 520-P01-A38-S144

## Metal Detectable & X-Ray Visible Bucket with Lid

**FR:** Seau à couvercle  
**ES:** Balde con tapa  
**DE:** Eimer mit Deckel

**1**  
PACK

A twelve litre detectable bucket with a lockable lid to protect contents and prevent spillages.



### Features & Options

- Metal detectable
- X-Ray visible
- Manufactured from EU and FDA food contact approved detectable polymer
- Lockable lid
- Detectable wall bracket available (505B-P01)
- Size: 12l (3 US gallon)
- Suitable for pad printing

**Colour:**

**Made In:**  
UK

**PRODUCT CODE:** 505-P01-S031-A42

## Metal Detectable & X-Ray Visible Bucket without Handle

FR: Seau sans anse  
 ES: Cubo sin asa  
 DE: Eimer ohne griff

**Made In:**  
**UK** 

**1**  
 PACK

This bucket is suitable for many uses in the food processing industry and is manufactured from detectable plastic approved to meet EU and FDA requirements for contact with food and consumable liquids.



### Features & Options

- Metal detectable
- X-Ray visible
- Manufactured from EU and FDA food contact approved detectable polymer
- Without handle
- Capacity: 9l (2.4 US gallon)
- Suitable for laser engraving

Colour: 

**PRODUCT CODE:** 505-P01-S028-A146

More product codes available – please contact us for a full price list

In Partnership with  
**BROS**

117

## Metal Detectable & X-Ray Visible Storage Box

FR: Boîtes de stockage  
 ES: Cajas de almacenamiento  
 DE: Vorratsbehälter

**1**  
 PACK

This is a versatile detectable storage box with a clip fastening lid, making it suitable for storing a number of items in the processing area.

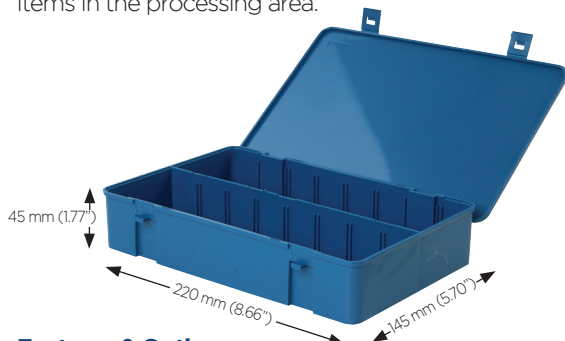

### Features & Options

- Metal detectable
- X-Ray visible
- Manufactured from EU and FDA food contact approved detectable polymer
- Lid with clip fastening
- Size: 220 x 145 x 45 mm (8.66 x 5.70 x 1.77")
- Suitable for pad printing/laser engraving

Colour: 

**Made In:**  
**UK** 

**PRODUCT CODE:** 503-P01-A42

## Metal Detectable & X-Ray Visible Storage Containers

FR: Conteneur de stockage  
 ES: Contenedor de almacenamiento  
 DE: Lagerbehälter

**5**  
 PACK

These stackable storage containers are available in two shapes and are made from detectable, food safe plastic.



### Features & Options

- Metal detectable
- X-Ray visible
- Manufactured from EU and FDA food contact approved detectable polymer
- Stackable
- Sizes: Square 117 x 117 x 74 mm (4.60 x 4.60 x 2.91")  
 Rectangular 190 x 128 x 78 mm (7.48 x 5.03 x 3.07")
- Suitable for pad printing/laser engraving

Colour: 

**Made In:**  
**UK** 

**PRODUCT CODE:** 507-S145-P01, 508-S140-P01

**detectamet**



## Metal Detectable & X-Ray Visible Disinfectant Wipe / Probe Wipe Dispenser

FR: Cuve de stockage

ES: Cubo de almacenamiento

DE: Vorratswanne

A detectable disinfectant wipe dispenser, available in two different sizes, perfect for use in food processing environments.



### Features & Options

- Metal detectable
- X-Ray visible
- With lid (detectable or non detectable)
- Size: small 170 mm (6.69") large 243 mm (9.56")
- Suitable for pad printing/ laser engraving

Colour:

*Other colours available on request (subject to MOQ)*

In Partnership with  
**BROS**

**PRODUCT CODE:** 433-S091-P01, 433-S089-P01

**118**

Sequential numbering available for all products • Ask us for a pen and knife guide

## Metal Detectable & X-Ray Visible Dustpan

FR: Ramasse-poussière

ES: Recogedor

DE: Kehrschaufel

This one-piece dustpan is available in four colours and has been ergonomically designed with thick ridges to trap the dirt into the pan.



### Features & Options

- Metal detectable
- X-Ray visible
- Manufactured from EU and FDA food contact approved detectable polymer
- One-piece
- Easy to clean
- Size: pan 300 x 160 x 50 mm (11.81 x 6.29 x 1.96"), handle length 130 mm (5.11")
- Suitable for pad printing/laser engraving

Colours:

*\*certain colours subject to MOQ\**

**PRODUCT CODE:** 511-PO

**etectamet**

# Pen Refills

## Fully Detectable Pen Refills

Our patent pending pen refills were the first on the market to be fully detectable, including the end cap.







**We sell refills!**

### Features & Options

**100  
PACK**



#### Ink type: standard

Colour	Product Code
	100-I51
	100-I52
	100-I53
	100-I54

**MANUFACTURED FROM  
DETECTABLE SHATTER  
PROOF PLASTIC**

#### Ink type: fine tip

Colour	Product Code
	100-I71
	100-I72

**WRITE OUT LENGTH  
APPROX. 9,400M  
(30,840')**

**FULLY DETECTABLE -  
INCLUDING END CAP**

#### Available for:

- HD retractable pen
- Elephant retractable pen
- Stainless steel retractable pen
- Metal stick pen



In Partnership  
with  
**BROGS**

**119**

**etectamet**  

# Metal & X-Ray Detectable Stackable Storage Tray with Lid

FR: Bacs de stockage à couvercles  
ES: Bandejas de almacenamiento con tapa  
DE: Ablageschalen mit Deckel



Available in nine colours, this stackable detectable storage container with lid is suitable for multi-purpose use.

## Features & Options



STACKABLE

WITH LID

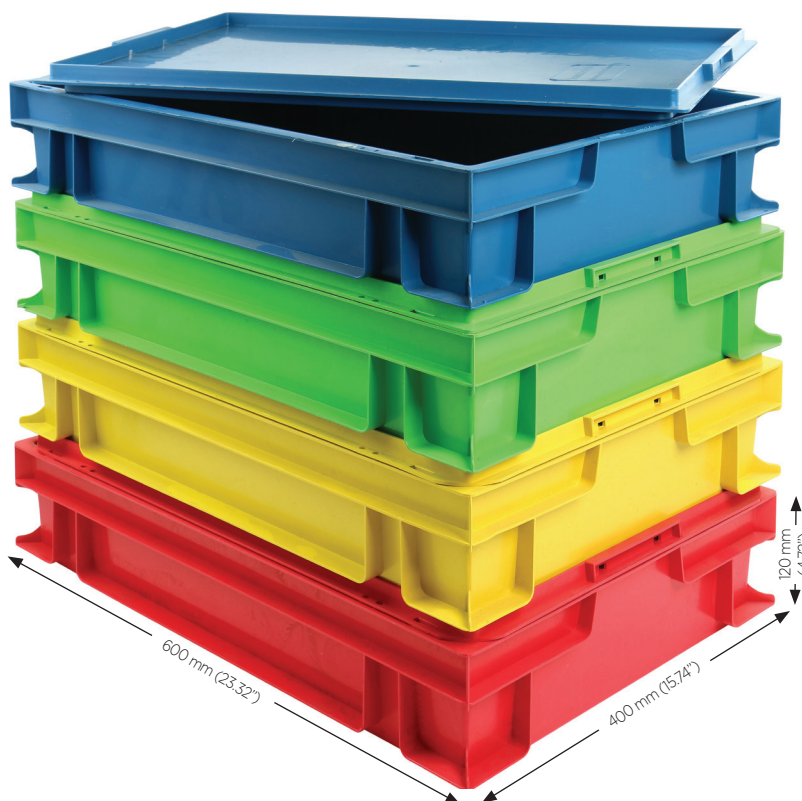

MANUFACTURED FROM EU & FDA FOOD CONTACT APPROVED DETECTABLE POLYMER

SUITABLE FOR PAD PRINTING/LASER ENGRAVING

### DIMENSIONS:

External length 600 mm (23.32"), width 400 mm (15.74"), depth 120mm (4.72")

Internal length 570 mm (22.44"), width 370 mm (14.56"), depth 115 mm (4.52")

Volume 20 litres (5.28 Gallons/1220 cubic inches)

Colours:

PRODUCT CODE: 534S-A40-PO

In Partnership with  
**BRCS**

120

etectamet

## Metal Detectable Double Sided Tape

FR: Ruban adhésif double face

ES: Cinta de dos lados

DE: Doppelseitiges Klebeband



Made In: UK

New Product!



This white multi-purpose, detectable tape comes in two sizes and has strong adhesion. This makes it ideal for the moist, rough or difficult surfaces typically encountered in the food and pharmaceutical industries.

**TEMPERATURE RESISTANCE**  
-10°C TO +70°C (14°F TO 158°F)

**SIZES:**  
small 50m x 25mm (164' x 0.98")  
large 50m x 50mm (164' x 1.96")

Colour:

**PRODUCT CODE:** 127-S980

More product codes available – please contact us for a full price list

In Partnership with  
**BREGS**

121

## Metal Detectable Multi-Purpose Detectortape

FR: DetectorTape

ES: DetectorTape

DE: DetectorTape



Made In: UK

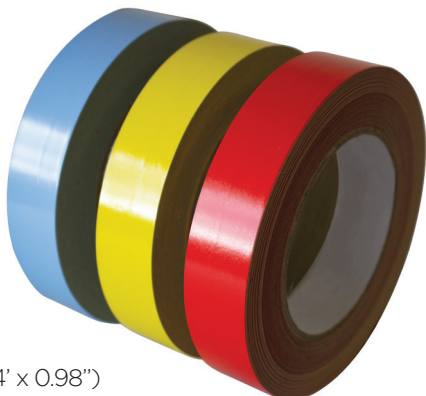

This multi-purpose, detectable tape comes in two sizes, three colours, and has strong adhesion. This makes it ideal for the moist, rough or difficult surfaces typically encountered in the food and pharmaceutical industries.

**SMALL SIZE:**  
small 50m x 25mm (164' x 0.98")

Colours:

**LARGE SIZE:**  
large 50m x 50mm (164' x 1.96")

**TEMPERATURE RESISTANCE**  
-10°C TO +70°C  
(14°F TO 158°F)

**STRONG ADHESIVE QUALITIES FOR VARYING ENVIRONMENTS**

**PRODUCT CODE:** 127-S89

etectamet



# Metal & X-Ray Detectable Disinfectant & Probe Wipe Dispenser Holder

FR: Porte-distributeur de lingettes désinfectantes & d'essuie-sondes

ES: Toallitas desinfectantes & dispensador de sonda

DE: halterung für desinfektionstücher und fühlerspender



This stainless steel or detectable plastic disinfectant and probe wipe dispenser holder is designed to hold one or two tubs of wipes and can be wall mounted.

## Features & Options



MANUFACTURED FROM EU AND FDA FOOD CONTACT APPROVED DETECTABLE POLYMER OR STAINLESS STEEL

HOLDS STANDARD TUBS OF DISINFECTANT AND PROBE WIPES

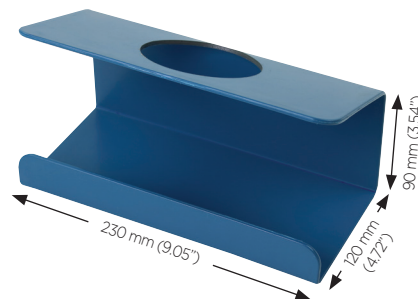
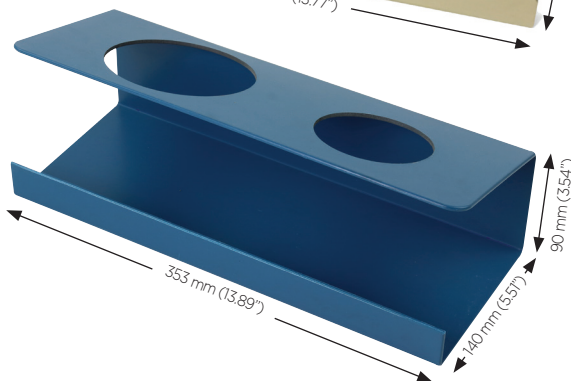
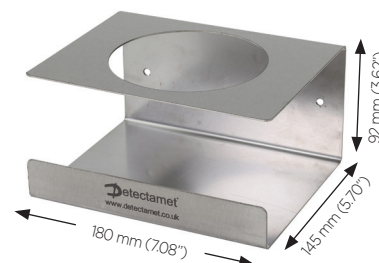

### SIZES:

Stainless steel single dispenser holder:  
180 x 145 x 92 mm  
(7.08 x 5.70 x 3.62")

Stainless steel disinfectant and probe wipe holder:  
350 x 140 x 115 mm  
(13.77 x 5.51 x 4.52")

Detectable plastic single dispenser holder:  
230 x 90 x 120 mm  
(9.05 x 3.54 x 4.72")

Detectable plastic disinfectant and probe wipe holder:  
353 x 90 x 140 mm  
(13.89 x 3.54 x 5.51")

Colour:

Colours:

PRODUCT CODE: 431-A25-X3

# Metal & X-Ray Detectable Wipe Dispenser and Spray Bottle Holder

FR: Porte-distributeur de lingettes désinfectantes & d'essuie-sondes

ES: Toallitas desinfectantes & dispensador de sonda

DE: halterung für desinfektionstücher und fühlerspender



Keep your cleaning equipment organised and accessible with these fully metal and X-ray detectable, wall mountable holders – available in single or double sizes.

## Features & Options



MANUFACTURED FROM  
EU AND FDA FOOD  
CONTACT APPROVED  
DETECTABLE POLYMER



HOLDS WIPE DISPENSERS  
AND TRIGGER SPRAY  
BOTTLES



WALL-  
MOUNTABLE



### SIZES:

Detectable plastic single dispenser holder  
156 x 105 x 90 mm  
(6.14 x 4.13 x 3.54")

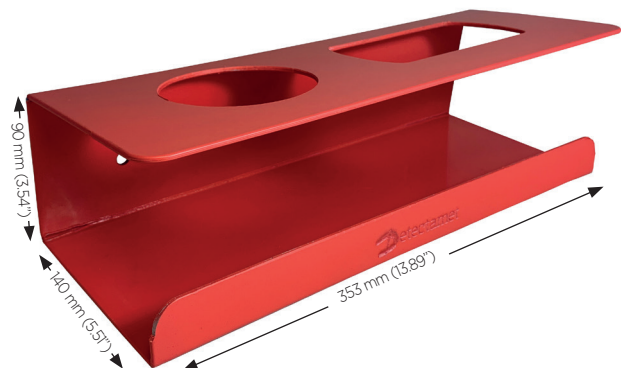

Detectable plastic double dispenser holder  
353 x 140 x 90 mm  
(13.89 x 5.51 x 3.54")

Colours:

PRODUCT CODE: 431-A25

In Partnership  
with  
**BROS**

123

**Detectamet**

# Metal & X-Ray Detectable Shelf

FR: Étagère visible au détecteur de métaux et aux rayons X

ES: Estante de metal detectable & visible en rayos X

DE: Metall- und röntgendetektierbares Regal



This sturdy shelf is manufactured from metal detectable & X-ray visible polymer, and is perfect for the food processing industry.

## Features & Options



### SIZE:

353 x 185 x 130 mm  
(13.89 x 7.28 x 5.11")

MANUFACTURED  
FROM DETECTABLE  
PLASTIC OR  
STAINLESS STEEL

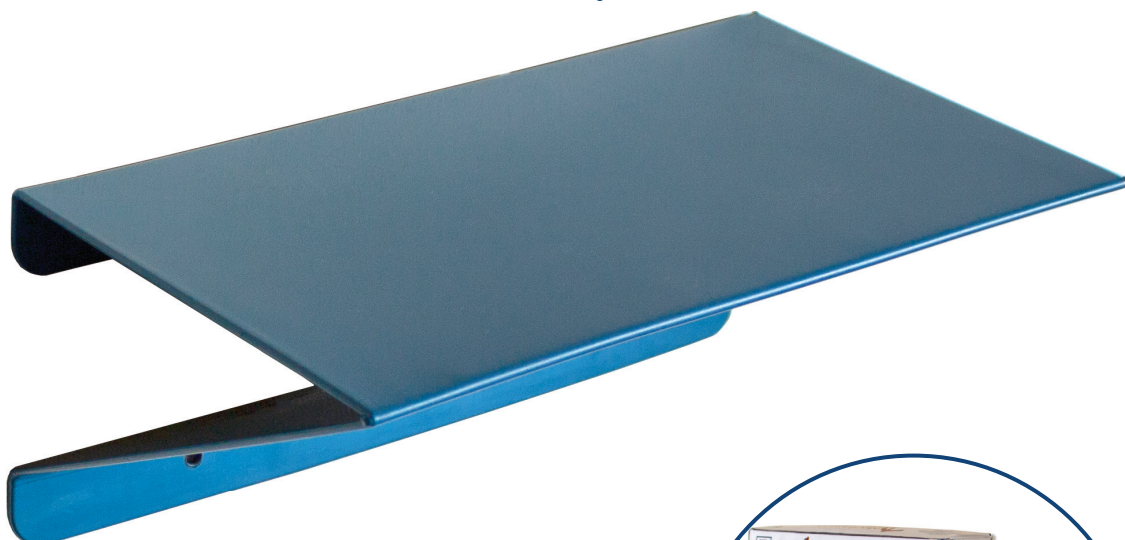

WALL MOUNTABLE  
WITH TWO  
PRE-DRILLED  
6 MM (0.23") HOLES



SUITABLE FOR  
LASER ENGRAVING

Colour:

Colours:

PRODUCT CODE: 109-P0 or P45

In Partnership  
with  
**BROS**

124

**Detectamet**



## Metal Detectable & X-Ray Visible Hand Sanitiser Bottle Holder

FR: Support désinfectant pour les mains

ES: Titular de desinfectante de manos

DE: Händedesinfektionsmittelhalter

Metal and X-ray detectable Hand Sanitiser Holder made from our unique detectable polymer. Available in 9 colours for added traceability.

**WALL MOUNTABLE WITH TWO PRE-DRILLED HOLES**

**SIZE:**  
78 x 62 x 85 mm  
(3.07 x 2.44 x 3.34")



### Features & Options



Colours:

**EASY TO CLEAN**

**SUITABLE FOR LASER ENGRAVING**

**PRODUCT CODE:** 431-A25

More product codes available – please contact us for a full price list

In Partnership with  
**BROGS**

125

## Metal Detectable & X-Ray Visible Paper Towel Holder



**SIZE:**  
250 x 85 x 200 mm  
(9.84 x 3.34 x 7.87")

**TO ACCEPT US STANDARD PAPER TOWELS**  
235 x 83 mm (9.25 x 3.26")

FR: Porte-serviettes en papier

ES: Dispensador de toallitas de papel

DE: Papiertücherhalter

Store your paper towels close to hand with our detectable holder.

**AVAILABLE IN DETECTABLE PLASTIC OR STAINLESS STEEL**

**WALL MOUNTABLE WITH TWO PRE-DRILLED 6 MM (0.23") HOLES**

**SUITABLE FOR LASER ENGRAVING**



**SUITABLE FOR LASER ENGRAVING**

**MANUFACTURED FROM EU AND FDA FOOD CONTACT APPROVED DETECTABLE POLYMER**



Colour:

Colours:

**PRODUCT CODE:** PLASTIC: 436-S572, STAINLESS STEEL: 435-S572

**detectamet**



# Metal & X-Ray Detectable Shovel

FR: Pelles à code couleur

ES: Palas codificadas por color

DE: Farbkodierte Schaufeln



This one-piece shovel is available in two different sizes and four colours, making it ideal for preventing cross contamination through colour coding.

## Features & Options



In Partnership with  
**BROS**

126

**Detectamet**



**SIZE:**

- small length 953 mm (37.51")
- blade size 271 x 327 mm (10.66 x 12.87")
- large length 1080 mm (42.51")
- blade size 271 mm x 327 mm (10.66 x 12.87")

Colours:

**PRODUCT CODE: 530R-S**

## Metal Detectable & X-Ray Visible Paddle without Holes

FR: Pelles à code couleur  
 ES: Palas codificadas por color  
 DE: Farbkodierte Schaufeln

This one-piece paddle is available in five colours, ensuring cross contamination is avoided.

**Made In:**  
**USA** 



**SIZE:**  
 length 1320 mm (51.96") paddle  
 head width 150 mm (5.90")

**ONE-PIECE**

**MANUFACTURED FROM  
 EU AND FDA FOOD  
 CONTACT APPROVED  
 DETECTABLE POLYMER**

### Features & Options

**1**  
 PACK

**SUITABLE FOR  
 PAD PRINTING**

Colours: 

**PRODUCT CODE:** 531-S

More product codes available – please contact us for a full price list

## Metal Detectable & X-Ray Visible Shovel

FR: Pelles  
 ES: Palas  
 DE: Schaufeln

This detectable shovel, available with two handle lengths, is suitable for a wide range of food processing jobs.



### Features & Options

- Metal detectable
- X-Ray visible
- One-piece
- Suitable for pad printing
- Manufactured from EU and FDA food contact approved detectable polymer
- Sizes:
  - short handled - shovel size 327 x 271 x 50 mm (12.87 x 10.66 x 1.96"), handle length 550 mm (21.65")
  - long handled - shovel size 327 x 271 x 50 mm (12.87 x 10.66 x 1.96"), handle length 1040 mm (40.94")

Colour: 

**PRODUCT CODE:** 530-S24

## Metal Detectable & X-Ray Visible Large Paddle

FR: Palettes  
 ES: Paletas  
 DE: Paddel

Specifically designed for the food processing industry, this detectable paddle has holes, making it suitable for stirring both high and low viscosity liquids.

### Features & Options

- Metal detectable
- X-Ray visible
- Manufactured from EU and FDA food contact approved detectable polymer
- One-piece
- With holes
- Size: length 1200 mm (47.25"), paddle head size 250 x 160mm (9.75 x 6.25")
- Suitable for pad printing

Colour: 

**PRODUCT CODE:** 531-S249-A50

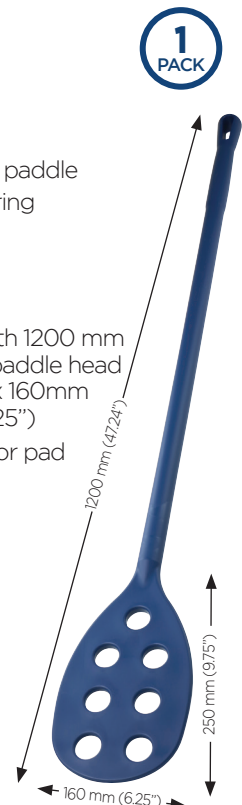

In Partnership  
 with  
**BROGS**

**127**

**etectamet**

## Metal Detectable Scouring Pad

### Features & Options

**10**  
PACK

Also sold in cases of 60

**DURABLE LONG LASTING ABRASIVE SCRUB PAD TO WITHSTAND HARSH FOOD PROCESSING ENVIRONMENTS**

**FR:** tampon à récurer à particules de métal détectables  
**ES:** Estropajo sensible para detectores de metal  
**DE:** metalldetektierbares Scheuervlies

These blue metal detectable scouring pads are highly visible and contain iron particles which can be detected in conventional end of line metal detectors, making them ideal for use in the food industry.

**New Product!**

**SIZE**  
225 x 150 x 9 mm  
(8.85 x 5.90 x 0.35")

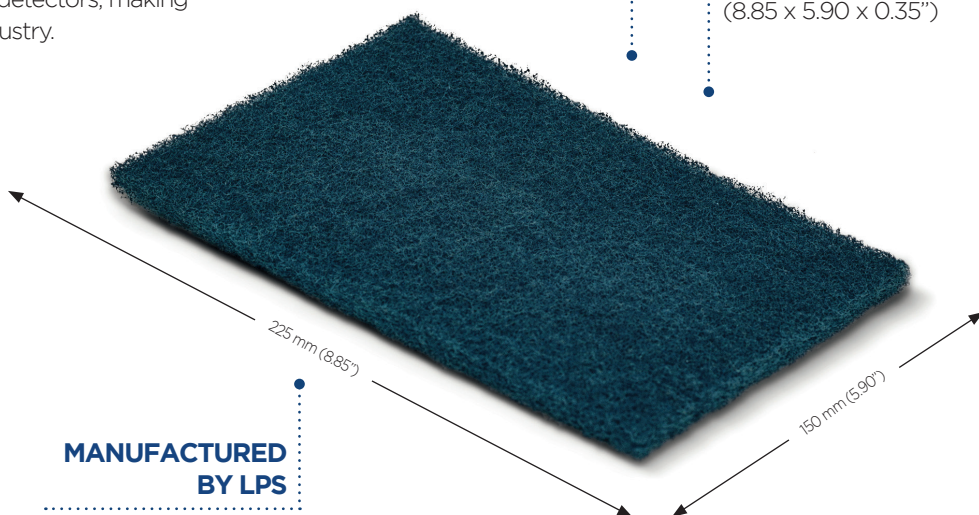

Colour:

**PRODUCT CODE:** 132-S972-P01

More product codes available – please contact us for a full price list

## Metal Detectable & X-Ray Visible Trigger Sprayer with Bottle

**FR:** pistolet pulvérisateur avec flacon, à particules de métal détectables, et utilisant un liquide visible aux UV  
**ES:** Pulverizador de gatillo con botella sensible para detectores de metal y rayos X  
**DE:** metall- und röntgendetektierbarer Sprühkopf mit Flasche

Metal and X-Ray Detectable Empty Trigger sprayer is affixed to a durable non-detectable plastic bottle onto which a metal detectable label has been applied. Reducing the risk of foreign matter contamination in production areas.

**ADJUSTABLE SPRAY STREAM TO ENSURE PROPER APPLICATION**

**MANUFACTURED BY LPS**

**ERGONOMIC, 3-FINGER TRIGGER TO REDUCE FINGER FATIGUE**



Colour:

**PRODUCT CODE:** 111-P01

# Resin-set Brushes for Double Detectability

We offer a range of brushes with fully detectable bristles that are **resin-set**. This is the most effective method for filament retention, and essential for eliminating the risk of foreign body contamination.

Features & Benefits



- FULLY DETECTABLE HANDLES**
- FULLY DETECTABLE BRISTLES**
- MOST EFFECTIVE METHOD OF FILAMENT RETENTION**
- ALL COMPONENTS MADE WITH EU/FDA FOOD SAFE APPROVED MATERIALS**
- THE SAFEST BRUSHES TO USE IN THE FOOD PROCESSING INDUSTRY**
- AUTOCCLAVABLE**  
up to 134°C (273°F)
- DESIGNED FOR LONG LASTING USE**
- EXCEPTIONALLY HYGIENIC**  
detectable resin prevents bacteria growth and accumulation of dirt and moisture
- BRISTLES SET WITH FOOD SAFE STAINLESS STEEL STAPLES AND FLOODED WITH AN ANTI-MICROBIAL DETECTABLE RESIN**

More product codes available – please contact us for a full price list

## Metal Detectable & X-Ray Visible Resin-Set Hand Brush with Medium Bristles

FR: Brosse dure à poignée courte  
 ES: Cepillo con cerdas duras de mango corto  
 DE: Harte Bürste mit kurzem Griff

Made In: UK 

This fully detectable ergonomic **resin-set** hand brush is light and agile with medium bristles.

Features & Options



- ONE-PIECE**
- RESIN-SET**
- DETECTABLE**
- FULLY MOULDED LOOP FOR HANGING**
- SUITABLE FOR PAD PRINTING**
- SIZE:**  
317 x 38 x 135 mm  
(12.48 x 1.49 x 5.31")
- MEDIUM DETECTABLE BRISTLES**

**RESIN-SET BRUSHES FOR DOUBLE DETECTABILITY**

Colour:

**PRODUCT CODE:** 512-A49-T120

In Partnership with **BROS**

129

**detectamet**



## Metal Detectable & X-Ray Visible Resin-Set Long Handled Brush

FR: Brosse dure à poignée longue

ES: Cepillo de cerdas duras con mango largo

DE: Harte bürste mit langem griff

A fully detectable **resin-set** long handled brush with stiff bristles, perfect for hard to reach areas.

Made In: UK

SUITABLE FOR PAD PRINTING

ONE-PIECE

FULLY MOULDED LOOP FOR HANGING

RESIN-SET

### Features & Options

1 PACK

RESIN-SET BRUSHES FOR DOUBLE DETECTABILITY

DETECTABLE

DETECTABLE



SIZE:

415 x 51 x 140mm  
(16.33 x 2.00 x 5.51")

STIFF BRISTLES

Colour: ■

PRODUCT CODE: 512-A49-T119

Sequential numbering available for all products • Ask us for a pen and knife guide

### Metal Detectable & X-Ray Visible Resin-Set Hand Brush with Stiff Bristles

FR: Brosse dure à poignée courte

ES: Cepillo con cerdas duras de mango corto

DE: Harte Bürste mit kurzem Griff

This fully detectable **resin-set** short handled brush with stiff angled bristles is perfect for hard to reach corners.

1 PACK



### Features & Options

- Metal detectable
- X-Ray visible
- Resin-set
- One-piece
- Stiff bristles
- Fully moulded loop for hanging
- Size: 220 x 68 x 90 mm (8.66 x 2.67 x 3.54")
- Suitable for pad printing

Colour: ■

Made In: UK

PRODUCT CODE: 512-A49-T121

### Metal Detectable & X-Ray Visible Resin-Set Nail Brush

FR: Brosse à ongles dure

ES: Cepillo de uñas con cerdas duras

DE: Harte nagelbürste

This fully detectable **resin-set** nail brush has stiff brushes and is ideal for removing heavy soiling from hands.

1 PACK



### Features & Options

- Metal detectable
- X-Ray visible
- Resin-set
- One-piece
- Stiff bristles
- Fully moulded loop for hanging
- Size: 122 x 44 x 33 mm (4.80 x 1.73 x 1.29")
- Suitable for pad printing

Colour: ■

Made In: UK

PRODUCT CODE: 512-A49-T122

# Fully Detectable Brushes & Brooms

Fully detectable brushes and brooms have every component, including the bristles, manufactured from metal detectable plastic approved for food contact use.

**DESIGNED FOR LONG LASTING USE**

**Features & Benefits**

**1 PACK**

**FULLY DETECTABLE HANDLE**

**FULLY DETECTABLE BRISTLES**

**AUTOCLAVABLE**  
up to 134°C (273°F)

**ALL COMPONENTS MADE WITH EU/FDA FOOD SAFE APPROVED MATERIALS**

In Partnership with  
**BREGS**

More product codes available – please contact us for a full price list

## Metal Detectable & X-Ray Visible Hand Brush

FR: Balayette souple

ES: Cepillo de mano con cerdas suaves

DE: Weiche handbürste

This fully detectable hand brush has a short handle and stiff bristles.

**Features & Options**

**1 PACK**

**DETECTABLE**

**SUITABLE FOR PAD PRINTING**

**FULLY MOULDED LOOP FOR HANGING**

**SIZE:**  
310 x 40 x 45 mm  
(12.20 x 1.57 x 1.77")

**STIFF BRISTLES**

**DETECTABLE**

148 mm (5.83")

148 mm (5.83")

162 mm (6.38")

Colour:

131

**Detectamet**

**PRODUCT CODE:** 510-T110-A147

## Metal Detectable & X-Ray Visible Hand Brush with Long Handle

FR: Brosse dure à poignée longue

ES: Cepillo de cerdas duras con mango largo

DE: Harte Bürste mit langem Griff

This fully detectable hand brush has a long handle and medium bristles, making it suitable for cleaning hard to reach areas.

### Features & Options

1  
PACK



Colour:

**PRODUCT CODE:** 510-T124-A46

Sequential numbering available for all products • Ask us for a pen and knife guide

## Metal Detectable & X-Ray Visible Nail Brush

FR: Brosse à ongles

ES: Cepillo de uñas

DE: Nagelbürste

1  
PACK

This fully detectable nail brush is available with both soft or medium bristles and has an ergonomic moulded grip.



### Features & Options

- Metal detectable
- X-Ray visible
- Fully moulded loop for hanging
- Soft or medium bristles
- Size: 94 x 44 x 43 mm (3.70 x 1.73 x 1.69")
- Suitable for pad printing

Colour:

**PRODUCT CODE:** 510-T111-A45, 510-T117-A45

## Metal Detectable & X-Ray Visible Cylinder Brush

FR: Brosse pour éprouvettes à pied

ES: Cepillo cilíndrico

DE: Zylinderbürste

1  
PACK

Available with two bristle strengths, this detectable cylinder brush is suitable for a variety of applications.



### Features & Options

- Metal detectable
- X-Ray visible
- Hole in handle for hanging
- Soft or medium bristles
- Size: 350 x 80 x 80 mm (13.77 x 3.14 x 3.14")
- Suitable for pad printing

Colour:

**PRODUCT CODE:** 510-T117-A45, 510-T117-A46

## Metal Detectable & X-Ray Visible Cylinder Brush for Long Handle

FR: Brosse cylindrique

ES: Cepillo de cilindro

DE: Zylinderbürste



This fully detectable cylinder brush fits onto our Detectable Handle (526-P01-A43) giving you great reach to clean vats and tanks.

### Features & Options

- Metal detectable
- X-Ray visible
- Head Size: 83 x 75 x 75 mm (3.27 x 2.95 x 2.95")

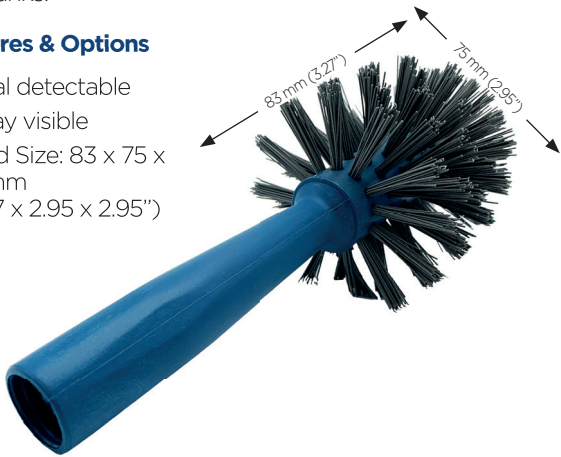

Colour:

**PRODUCT CODE:** 510-T470-A221

## Metal Detectable & X-Ray Visible Round Hand Brush

FR: Brosse à main ronde

ES: Cepillo de mano redondo

DE: Runde Handbürste



Fully detectable round handheld brush.

### Features & Options

- Metal detectable
- X-Ray visible
- Handle diameter: 65 mm (2.56")
- Brush diameter: 115 mm (4.53")
- Height: 98 mm (3.86")



Colour:

**PRODUCT CODE:** 510-T592-A46

In Partnership with  
**BREGS**

133

Sequential numbering available for all products • Ask us for a pen and knife guide

## Metal Detectable & X-Ray Visible Large Hand Brush

FR: Grande brosse à main

ES: Cepillo de mano grande

DE: Große Handbürste



This large hand brush features an ergonomic handle and medium bristles.



### Features & Options

- Metal detectable
- X-Ray visible
- Detectable ergonomic blue hand grip
- Size: 192 mm (7.56") x 54 mm (2.13") x 53 mm (2.09")

Colour:

**PRODUCT CODE:** 510-T596-A46

## Metal Detectable & X-Ray Visible Short Handled Brush

FR: Poignée pour raclette

ES: Mango para escobilla de goma

DE: Griff passend für Gummiwischer



This short handled brush with medium bristles is perfect for day-to-day scrubbing of a variety of surfaces.



### Features & Options

- Metal detectable
- X-Ray visible
- Size: 1450 mm (57.08")
- Hole in handle for hanging
- Detectable ergonomic blue handle grip

Colour:

**PRODUCT CODE:** 510-T594-A46

Detectamet



## Metal Detectable & X-Ray Visible Dish Brush

FR: Brosse à vaisselle  
 ES: Cepillo para platos  
 DE: Spülbürste



This detectable dish brush is available with two bristle strengths.



### Features & Options

- Metal detectable
- X-Ray visible
- Hole in handle for hanging
- Soft or medium bristles
- Size: 235 x 42 x 40 mm (9.25 x 1.65 x 1.57")
- Suitable for pad printing

Colour:

**PRODUCT CODE:** 510-T112-A45, 510-T112-A46

## Metal Detectable & X-Ray Visible Floor Brush

FR: Brosse à plancher  
 ES: Cepillo de piso  
 DE: Schrubber



This detectable floor brush is available in two sizes, comes with medium bristles, and is suitable for use with our detectable handles.



### Features & Options

- Metal detectable
- X-Ray visible
- Medium bristles
- Sizes:
  - small 280 x 60 x 70 mm (11.02 x 2.36 x 2.75")
  - large 460 x 65 x 90 mm (18.11 x 2.55 x 3.54")

Colour:

**PRODUCT CODE:** 510-T115-A46, 510-T115-A45

More product codes available – please contact us for a full price list

## Metal Detectable & X-Ray Visible Push Broom

FR: Balai-brosse  
 ES: Escoba de empuje  
 DE: Besen



This detectable push broom is available in two sizes and bristle stiffness, making it suitable for a range of applications. Suitable for use with our detectable handles.



### Features & Options

- Metal detectable
- X-Ray visible
- Soft & medium bristles
- Sizes:
  - small 340 x 75 x 115 mm (13.38 x 2.95 x 4.52")
  - large 480 x 80 x 130 mm (18.89 x 3.14 x 5.11")

Colour:

**PRODUCT CODE:** 510-T113-A45, 510-T113-A46

## Metal Detectable & X-Ray Visible Tabletop Squeegee

FR: Raclette de table à poignée  
 ES: Escobilla de goma con mango para superficies  
 DE: Tisch-Gummiwischer mit Griff



This detectable ultra hygienic squeegee has a short handle, making it ideal for removing water from tabletops.

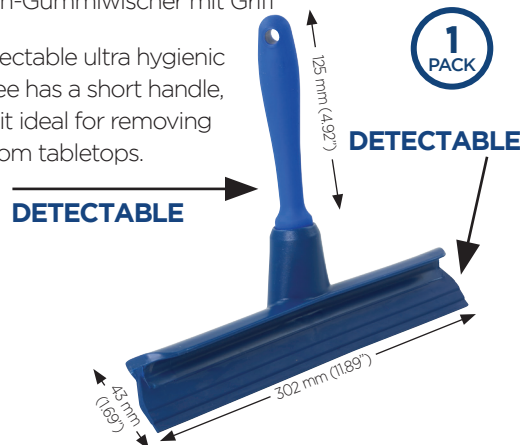

### Features & Options

- Metal detectable
- X-Ray visible
- Size: squeegee - 60 x 93 x 302 mm (2.36 x 3.66 x 11.88"), handle length - 173 mm (6.81")

Colour:

**PRODUCT CODE:** 526-P01-A28

## Metal Detectable & X-Ray Visible Floor Squeegee

**FR:** Raclette pour sols  
**ES:** Escobilla para el suelo  
**DE:** Bodenschaber

1  
PACK

This detectable ultra hygienic floor squeegee can be used with our range of handles, making it perfect for removing water in food processing areas.

### Features & Options

- Metal detectable
- X-Ray visible
- Resilient **DETECTABLE**
- Size: squeegee - 600 x 40 x 90 mm (23.62 x 1.57 x 3.54")



**DETECTABLE**

**Colour:** ■

**PRODUCT CODE:** 526-P01-A29

## Metal Detectable & X-Ray Visible Stainless Steel Floor Scraper

**FR:** Grattoir de sol à lame flexible en acier inoxydable  
**ES:** Rasqueta para pisos con hoja flexible de acero inoxidable  
**DE:** Bodenschaber mit flexibler Edelstahlklinge

1  
PACK

A stainless steel floor scraper with a flexible blade, suitable for removing food debris from your processing floor.

### Features & Options

- Metal detectable
- X-Ray visible
- Flexible blade
- Replacement blade available
- Length: 1315 mm (51.75")
- Blade size: 195 mm (7.67")
- Suitable for laser engraving

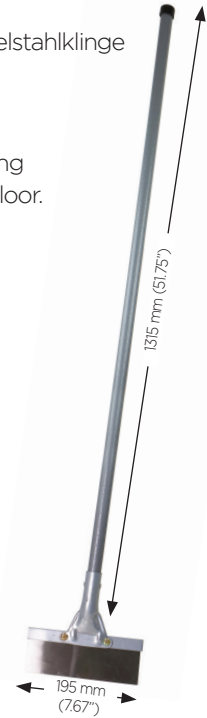

**Colour:** ■

**PRODUCT CODE:** 677-S628

Sequential numbering available for all products • Ask us for a pen and knife guide

## Metal Detectable & X-Ray Visible Stainless Steel Handle with Detectable Grip

**FR:** Poignée pour raclette  
**ES:** Mango para escobilla de goma  
**DE:** Griff passend für Gummiwischer

This long stainless steel handle with a detectable blue grip is suitable for use with brooms and squeegees.

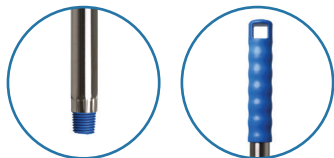

1  
PACK

### Features & Options

- Metal detectable
- X-Ray visible
- Detectable blue hand grip
- For use with floor brushes, squeegees and push brooms
- Size: 1350 mm (53.14")
- Diameter: 21 mm (0.82")
- Thread Diameter: 17 mm (0.66")

**Colour:** ■

**PRODUCT CODE:** 526-P01-A48

## Metal Detectable & X-Ray Visible Fully Detectable Handle

**FR:** Poignée pour raclette  
**ES:** Mango para escobilla de goma  
**DE:** Griff passend für Gummiwischer

This fully detectable handle with a detectable blue grip is suitable for use with brooms and squeegees.



1  
PACK

### Features & Options

- Metal detectable
- X-Ray visible
- For use with floor brushes, squeegees and push brooms
- Size: 1450 mm (57.08")
- Diameter: 23 mm (0.90")
- Thread Diameter: 18 mm (0.71")

**Colour:** ■

**PRODUCT CODE:** 526-P01-A43

## Metal Detectable & X-Ray Visible Health & Safety Signs

FR: Panneaux d'hygiène et de sécurité

ES: Carteles de salud y seguridad

DE: Gesundheitsschutz- und Sicherheitskennzeichnungen

Health and safety signs are crucial in any business and we offer a wide range of wall mountable standard signs.

### Features & Options

1  
PACK



Wash Your Hands

detectamet Available upon request www.detectamet.co.uk



Wear Face Shields

detectamet Available upon request www.detectamet.co.uk

**THIS IS A BESPOKE PRODUCT SO PLEASE TALK TO A SALES REPRESENTATIVE FOR MORE DETAILS**

### SIZES:

A3 size 297 x 420 mm (11.69 x 16.53")

A4 size 210 x 297 mm (8.26 x 11.69")

A5 size 148 x 210 mm (5.82 x 8.26")

### Colour:



### Features & Options

- Metal detectable
- X-Ray visible
- This is a bespoke product so please talk to a sales representative for more details.
- Size:  
Face of sign: 600 x 300 mm (23.62 x 11.81")  
Span when open: 520 mm (20.47")



Colour:

**PRODUCT CODE:** 380-S0

**PRODUCT CODE:** 464-T130

More product codes available – please contact us for a full price list

## Metal Detectable Health & Safety Floor Stickers

FR: Autocollants au sol

ES: Pegatinas de piso

DE: Bodenaufkleber



Keep your workplace organised and your workforce safe with our metal detectable floor stickers. With strong adhesive to the back of the sticker, these will stick to floors, carpets and walls. Custom sizes are available upon request.

### Features & Options

25  
PACK



### SIZE:

254 mm (10") Diameter

**PRODUCT CODE:** 405

**CUSTOM SIZES & DESIGNS AVAILABLE UPON REQUEST**

**New Product!**



**STRONG ADHESIVE STICKS TO WALLS AND FLOORING**



# Metal & X-Ray Detectable Floor Sign

FR: Signe de plancher

ES: Señal de piso

DE: Bodenschild



Metal detectable & X-ray visible Floor Sign, available in 9 vibrant colours. Alongside our range of standard sign messages, we can also provide customised signage with any sign design and language. Please get in touch for more information.

## Features & Options

New Product!

1 PACK

CUSTOMISABLE SIGNAGE AVAILABLE SUBJECT TO MINIMUM ORDER QUANTITY



AVAILABLE IN 9 VIBRANT COLOURS

FOLDS FLAT FOR CONVENIENT STORAGE



### SIZES:

Height: 425 mm (16.73")

Width Top: 240 mm (9.44")

Width Bottom: 280 mm (11.02")

Floor Span: 320 mm (12.59")

Colours:



In Partnership with

**BROS**

137

**Detectamet**

PRODUCT CODE: 404-PO



## Metal Detectable & X-Ray Visible Stainless Steel Shovels & Spades

FR: Pelles en acier inoxydable multi-usages

ES: Palas multifunción de acero inoxidable

DE: Mehrzweckschaufeln aus Edelstahl

A range of shovels and spades made from 304 stainless steel which are certified NSF/ANSI standard 2 food equipment.

### Features & Options



Sold individually in USA

AVAILABLE IN STANDARD OR REINFORCED STAINLESS STEEL

NSF/ANSI CERTIFIED



SHOVEL OR SQUARE BLADES

Colour:

### SIZES:

- blade 279 x 178 mm (10.98 x 7.00"), overall length 991 mm (39.01")
- blade 318 x 241 mm (12.51 x 9.48"), overall length 1016 mm (40.00")
- blade 356 x 267 mm (14.01 x 10.51"), overall length 991 mm (39.01")
- blade 394 x 292 mm (15.51 x 11.49"), overall length 1016 mm (40.00")
- blade 432 x 349 mm (17.00 x 13.74"), overall length 1118 mm (44.01")

PRODUCT CODE: 670

Sequential numbering available for all products • Ask us for a pen and knife guide

## Metal Detectable & X-Ray Visible Stainless Steel Paddles

FR: Palettes en acier inoxydable

ES: Paletas de acero inoxidable

DE: Paddel aus Edelstahl

These stainless steel paddles are available in four lengths, manufactured from 304 stainless steel and are certified NSF/ANSI standard 2 food equipment.

### Features & Options

- Metal detectable
- X-Ray visible
- NSF/ANSI certified
- Sizes: lengths 914, 1067, 1219 & 1524 mm (35.98, 42.00, 47.99 & 60.00")
- blade 248 x 121 mm (9.76 x 4.76")
- Suitable for laser engraving



Sold individually in USA



Colour:

PRODUCT CODE: 671-S06

## Metal Detectable & X-Ray Visible Stainless Steel Forks

FR: Fourchettes en acier inoxydable

ES: Horquetas de acero inoxidable

DE: Gabeln aus Edelstahl

These forks are available in two sizes, manufactured from 304 stainless steel and are certified NSF/ANSI standard 2 food equipment.

### Features & Options

- Metal detectable
- X-Ray visible
- NSF/ANSI certified
- Fork tip sizes: 305 x 216 mm (12.00 x 8.50") 4 tines
- 305 x 305 mm (12.00 x 12.00") 5 tines
- 229 x 210 mm (9.00 x 8.26") 4 tines
- Overall length: 1118, 1524 mm (44.01, 60.00")
- Suitable for laser engraving



Sold individually in USA

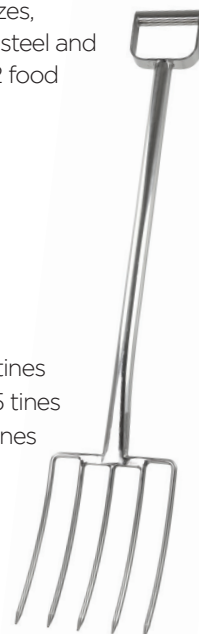

Colour:

PRODUCT CODE: 672-T133

## Metal Detectable & X-Ray Visible Stainless Steel Scoops

FR: Pelles en acier inoxydable

ES: Cucharones de acero inoxidable

DE: Kellen aus Edelstahl

Available in nine different sizes, these scoops are manufactured in 304 stainless steel and are certified NSF/ANSI standard 2 food equipment. This makes them suitable for direct food use.

### SIZES:

227g (8oz) 70 x 102 mm (2.75 x 4.00")  
handle length 102 mm (4.00")

454g (16oz) 85 x 130 mm (3.34 x 5.11")  
handle length 102 mm (4.00")

907g (32oz) 114 x 168 mm (4.48" x 6.61")  
handle length 102 mm (4.00")

1814g (64oz) 127 x 210 mm (5 x 8.26")  
handle length 102 mm (4.00")

2722g (96oz) 140 x 241 mm (5.51 x 9.48")  
handle length 102 mm (4.00")

3629g (128oz) 159 x 216 mm (6.25 x 8.50")  
handle length 114 mm (4.48")

4536g (160oz) 216 x 254 mm (8.50 x 10")  
handle length 127 mm (5.00")

### Features & Options



Sold individually  
in USA

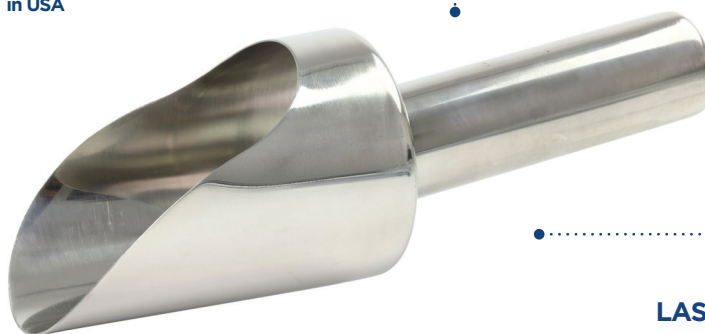

NSF/ANSI  
CERTIFIED

SUITABLE FOR  
LASER ENGRAVING

Colour:

PRODUCT CODE: 673-S56

More product codes available – please contact us for a full price list

## Metal Detectable & X-Ray Visible Stainless Steel Pharma Scoops

FR: Pelles pharmaceutiques en acier inoxydable

ES: Cucharones farmacéuticos de acero inoxidable

DE: Probeschaufeln aus Edelstahl

Available in nine different sizes, these pharma scoops are manufactured in 316 stainless steel, making them highly resistant to corrosion and are certified NSF/ANSI standard 2 food equipment.

### SIZES:

227g (8oz) 102 x 152 mm (4.01 x 5.98")  
handle length 127 mm (5.00")

454g (16oz) 127 x 197 mm (5.00 x 7.75")  
handle length 127 mm (5.00")

907g (32oz) 127 x 229 mm (5.00 x 9.01")  
handle length 127 mm (5.00")

1417g (50oz) 140 x 229 mm (5.51 x 9.01")  
handle length 127 mm (5.00")

1814g (64oz) 152 x 305 mm (5.98 x 12.00")  
handle length 127 mm (5.00")

### Features & Options



Sold individually  
in USA



STRAIGHT AND ERGO  
HANDLES AVAILABLE

NSF/ANSI  
CERTIFIED

SUITABLE FOR  
LASER ENGRAVING

Colour:

PRODUCT CODE: 674-S56

## Metal Detectable & X-Ray Visible Stainless Steel Pails

FR: Seaux en acier inoxydable multi-usages

ES: Baldes multifunción de acero inoxidable

DE: Mehrzweckeimer aus Edelstahl

Available in two sizes, with/without secondary side lift handle, these pails are manufactured from 304 stainless steel and are certified NSF/ANSI standard 2 food equipment.

**NSF/ANSI  
CERTIFIED**



**AVAILABLE  
WITH SIDE  
LIFT HANDLE**

### Features & Options

**3  
PACK**

Sold individually  
in USA



### CAPACITY:

one handle 14.75l  
(3.9 US gallons)  
two handles 14.75l  
(3.9 US gallons),  
18l (4.8 US gallons)

Colour:

PRODUCT CODE	SIZE
675-A181	Stainless Steel Pail 13-Quart
675-A182	Stainless Steel Pail 13-Quart with Handle
675-A184	Stainless Steel Pail 16-Quart with Handle

Sequential numbering available for all products • Ask us for a pen and knife guide

## Metal Detectable & X-Ray Visible Stainless Steel Bucket with Lid

FR: Seaux et couvercles en acier inoxydable

ES: Cubo de acero inoxidable con tapa

DE: Edelstahlleimer und deckel

This 304 stainless steel bucket is available with a choice of standard base, reinforced or draining foot. The draining foot bucket also comes with a spout.

**MANUFACTURED FROM  
304 STAINLESS STEEL**

**NSF/ANSI CERTIFIED**

**LIDS AVAILABLE  
FOR STANDARD AND  
REINFORCED FOOT STYLES**

### Features & Options

**1  
PACK**



### CAPACITIES:

Standard bucket available in 10, 12 and 15l (2.6, 3.2 and 4 US gallon)  
Bucket with reinforced foot available in 10, 12 and 15l (2.6, 3.2 and 4 US gallon)  
Bucket with spout and draining foot available in 10, 12, 15 and 20l (2.6, 3.2, 4 and 5.3 US gallon)

**SUITABLE FOR  
LASER ENGRAVING**

Colour:

**PRODUCT CODE:** 562-P32-SO, 571-P32-SO, 572-P44-SO, 587-P45-SO

## Metal Detectable & X-Ray Visible Stainless Steel Whisk

FR: Fouets en acier inoxydable  
 ES: Batidoras de acero inoxidable  
 DE: Edelstahl Schneebesen

This whisk is manufactured from 304 stainless steel, has a watertight seal and is available in different sizes.

MANUFACTURED FROM 304 STAINLESS STEEL WITH WATERTIGHT SEALS

NSF/ANSI CERTIFIED

1  
PACK

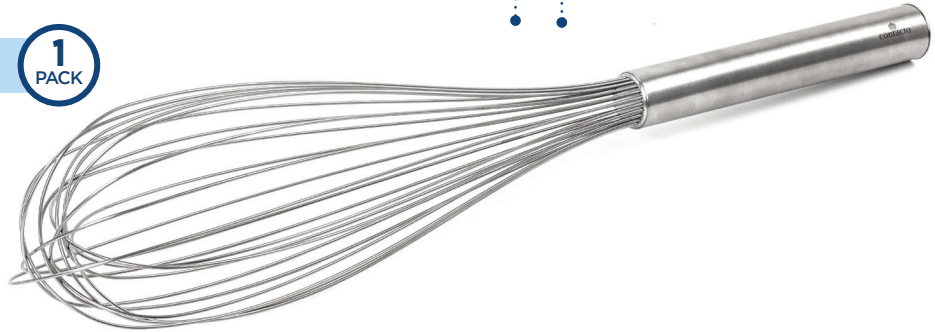

### Features & Options

Colour: 

PRODUCT CODE	SIZE
590-P44-S079	Overall length 400mm (15.74"), wire diameter 1.3mm (0.05"), handle length 160mm (6.29")
590-P44-S081	Overall length 450mm (17.71"), wire diameter 1.3mm (0.05"), handle length 160mm (6.29")
590-P44-S082	Overall length 500mm (19.68"), wire diameter 1.3mm (0.05"), handle length 160mm (6.29")

Other sizes available. Please ask a sales representative for more details.

More product codes available – please contact us for a full price list

## Metal Detectable & X-Ray Visible Stainless Steel Bowl

FR: Bols en acier inoxydable  
 ES: Boles de acero inoxidable  
 DE: Edelstahlschüsseln

This high quality 304 stainless steel mixing bowl is available in different sizes.

MANUFACTURED FROM 304 STAINLESS STEEL WITH WATERTIGHT SEALS

ROLLED EDGE TO AVOID SHARPNESS

1  
PACK



NSF/ANSI CERTIFIED

SUITABLE FOR LASER ENGRAVING

Colour: 

PRODUCT CODE	SIZE
559-P32-S030	1l (38.7oz) base dia. 215 mm (8.46"), height 180 mm (7.08") inside dia. 355 mm (13.97")
559-P32-S006	0.5L (17.6oz) base dia. 75 mm (2.95"), height 70 mm (2.75") inside dia. 120 mm (4.72")
559-P32-S021	3L (105.6oz) base dia. 140mm (5.51"), height 125 mm (4.92") inside dia. 220 mm (8.66")
559-P32-S012	1l (35.2oz) base dia. 95 mm (3.74"), height 80 mm (3.14") inside dia. 150 mm (5.90")

Other sizes available. Please ask a sales representative for more details.



## Metal Detectable & X-Ray Visible Stainless Steel Measuring Jug

FR: Cruches graduées en acier inoxydable

ES: Vasos medidor de acero inoxidable

DE: Edelstahlmessbecher

This 304 stainless steel measuring jug is suitable for all food processing requirements.

MANUFACTURED FROM 304 STAINLESS STEEL WITH WATERTIGHT SEALS



Colour:



### Features & Options

1  
PACK

PRODUCT CODE	SIZE
567-T162-P45-S001	0.1l (3.5oz) height 50 mm (2")
567-T162-P45-S003	0.25l (8.8oz) height 70 mm (2.75")
567-T162-P45-S006	0.5l (17.6oz) height 110 mm (4.33")
567-T162-P45-S012	1l (35.2oz) height 135 mm (5.31")
567-T162-P45-S018	2l (70.4oz) height 195 mm (7.67")

In Partnership with  
**BRCGS**

Other styles available. Please ask a sales representative for more details.

Sequential numbering available for all products • Ask us for a pen and knife guide

## Metal Detectable & X-Ray Visible Stainless Steel Funnel

FR: Entonnoirs en acier inoxydable

ES: Embudos de acero inoxidable

DE: Edelstahltrichter

This 304 stainless steel funnel is ideal for food processing applications.

HANGING LOOP

NSF/ANSI CERTIFIED

MANUFACTURED FROM 304 STAINLESS STEEL



### Features & Options

1  
PACK

Colour:

PRODUCT CODE	SIZE
565-T161-P32-S414	1000 ml (35.2 fl oz) nozzle dia. 22 mm (0.86") height 200 mm (7.87") inside dia. 190 mm (7.48")
565-T161-P32-S415	2000 ml (70.4 fl oz) nozzle dia. 22 mm (0.86") height 220 mm (7.87") inside dia. 220 mm (8.66")

Other styles available. Please ask a sales representative for more details.

# Metal & X-Ray Detectable Stainless Steel Tote Bin Cover Dispenser

**FR:** Distributeur de housses de poubelle en acier inoxydable

**ES:** Expendedor de cubiertas para contenedores de acero inoxidable

**DE:** Spender aus Edelstahl für Einweg-Vorratsbehälterabdeckungen

This 304 grade stainless steel tote bin cover dispenser has a fill lever indicator on the side, and holds a roll of 250 tote bin covers.

## Features & Options



**WALL  
MOUNTABLE**

**SUITABLE FOR  
LASER ENGRAVING**

**Colour:**

**SIZES:**

770 x 220 x 220 mm  
(30.31 x 8.66 x 8.66")

**PRODUCT CODE:** 589-T198

In Partnership  
with

**BROS**

**143**

**Detectamet**

# Metal Detectable or Non Detectable Tote Bin Covers

FR: Housses de poubelle jetables

ES: Cubiertas para contenedores desechables

DE: Einwegabdeckung für Vorratsbehälter



These disposable polythene tote bin covers are available in either detectable or non detectable variants and are suitable for use in the food industry.

## Features & Options



 **METAL  
DETECTABLE**  
(if selected)

**COVER 200/300 LITRE  
(53/79 GALLONS)  
TOTE BINS**

**ONLY DETECTABLE  
VERSION AVAILABLE  
IN THE US**

**TOTE BIN COVERS  
SUPPLIED ON A ROLL**



**SIZES:**

length 830mm (32.67")  
width 620mm (24.40")  
gusset 120mm (4.72")

**THICKNESS**

38 micron (1.5 mils)



Colours: 

**PRODUCT CODE: 545-A6**

In Partnership with  
**BRCS**

144

**etectamet**



## Metal Detectable Polythene Bags and Liners

**FR:** Sacs et doublures en polyethylene

**ES:** Bolsa y revestimientos de polietileno

**DE:** Plastiktüte Taschen und Folien

A high proportion of foreign body contamination is due to bulk and product packaging failure, so we have developed detectable bags and liners manufactured from detectable polythene. This is a bespoke product so please talk to a sales representative for more details.

**SIZE: THIS IS A  
BESPOKE PRODUCT -  
ANY SIZE IS POSSIBLE**

### Features & Options

VARIOUS  
PACKS



### SUITABLE FOR MANY APPLICATIONS, INCLUDING:

- Box liners
- Heavy duty ingredients bags
- Extra large tote bin covers
- Pallet covers
- Sheets and film

Colours:

**PRODUCT CODE:** 871-PO

More product codes available – please contact us for a full price list

## Metal Detectable or Non Detectable Extra Large Tote Bin Covers

**FR:** Couvercle de poubelle multidimensions

**ES:** Cubierta para contenedores de varios tamaños

**DE:** Behälterdeckel in Multigröße

These detectable extra large tote bin covers are reusable and suitable for multiple uses within the food industry.

**Made In:**  
**UK**

### Features & Options

5  
PACK



### SIZE RANGE:

600 - 2200 mm x 500 - 1750 mm  
(23.62 - 86.61 x 19.68 - 68.89")

Colour:

**PRODUCT CODE:** 545-A217-P01-X30

In Partnership  
with

**BROGS**

145

**detectamet**



# Detectamet Offer Own Branding & Sequential Numbering

**Perfect for knives and other products, sequential numbering is done in-house on our laser engraving machine.**

Sequential numbering gives you complete traceability and is particularly important if production presents higher risks, making it even more important to eliminate any type of contamination.

Our cost effective laser engraving service adds sequential numbers onto your products.

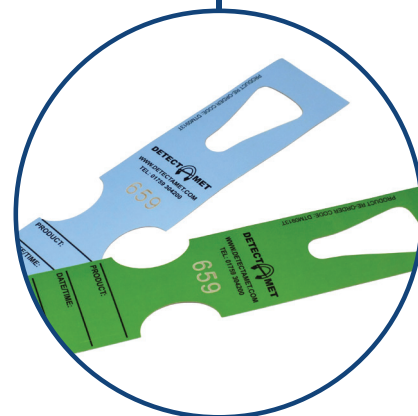

**How about branding your detectable products using our cost effective pad printer?**

Pad printing offers superior quality one and two colour print on 3D irregular, curved and textured objects, making it perfect for our products.

**Where pad printing and laser engraving are not appropriate - due to the product - we can print your logos at point of manufacture, e.g. keyhole tags, test pieces. Ask a member of our team for advice.**



**Can't see what you're looking for?**

**Or are you looking for a detectable product for a specific project or application?**

**Don't worry!** We're always happy to talk about bespoke products and will always try our best to find a solution.



## Metal Detectable and X-Ray Visible Pallet Bands

FR: Bande de palette

ES: Banda de paleta

DE: Palettenband

Our metal and X-ray detectable elastic pallet band keeps pallets together and organised. Our pallet bands stretch to twice their original length.



**SIZES:**  
1210 mm (47.6") band length



Colours:

**PRODUCT CODE:** 821-1030

More product codes available – please contact us for a full price list

In Partnership with  
**BROGS**

147

## Metal Detectable & X-Ray Visible Bag Closure Clips

FR: Clip/baguette de fermeture de sac

ES: Broche/cierre para bolsas

DE: Tütenklammer / Tütenverschluss



These blue detectable bag clips are available in two sizes and are perfect for multiple food factory uses, including keeping ingredients fresh.



**SIZES:**  
small length 178 mm (7")  
large length 362 mm (14.25")



REUSABLE

SUITABLE FOR PAD PRINTING

Colour:

**PRODUCT CODE:** 804-S910 (small)

**PRODUCT CODE:** 804-S236 (large)

## Metal Detectable Bag Grippers

FR: Pince de préhension/de fermeture

ES: Sujetador/sellador para bolsas

DE: Beutelgreifer / Beutelverschluss



These blue, reusable bag grippers are available in two sizes and are suitable for all food processing environments.

REUSABLE



**SIZES:**  
small length 245 mm (9.64")  
large length 315 mm (12.40")

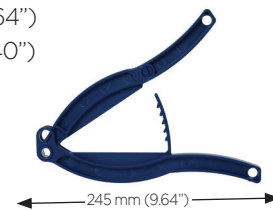

Colour:

**PRODUCT CODE:** 805-S231-T098S (small)

**PRODUCT CODE:** 805-S886-T098 (large)

etectamet

# Metal Detectable & X-Ray Visible Tags, Labels & Seals



**FR:** Etiquettes et clips

**ES:** Etiquetas y clips

**DE:** Etiketten & Clips

148

Lot Dividers	149
Keyhole Loop Tags	150
Tag Dispenser	151
Reusable/Releasable Nylon Cable Ties	152
Nylon Cable Ties	152
Nylon Cable Ties with Stainless Steel Lock	153
Polypropylene Cable Ties with Stainless Steel Lock	153
Cable Tie Mounts	154
Cable Identification Tags	154
Cable Organiser	154
Cable Clamps	154
Security Seals	155
Security Seals with Sequential Numbering	156
Circular Identification Tags	157
Looped Identification Tags	157
Identification and Lockout Tags	157
Shadow Boards & Security Cage	158
Shadow Boards	158-159
Shadow Board Accessories	160

# Metal & X-Ray Detectable Lot Dividers

FR: Diviseur de lot

ES: Divisor de lotes

DE: Lotteiler

Metal detectable & X-ray visible lot dividers. Ideal for counting and distinguishing produce on a food factory conveyor system.



## Features and benefits

**6**  
Per Pack

**New Product!**



### BESPOKE SIZING AVAILABLE

We can manufacture bespoke sizes for our lot dividers.

Please talk to a sales representative for more details.

### IDEAL FOR COUNTING AND DISTINGUISHING PRODUCE ON A CONVEYOR SYSTEM

### AVAILABLE IN 9 COLOURS

Our lot dividers are available in 9 colours, making colour coding more achievable in a manufacturing environment.

### SIZE

Our lot dividers are 200 mm x 104 mm x 3 mm (7.87" x 4.09" x 0.11") as a standard size.



**PRODUCT CODE: 990-P01**

In Partnership with

**BREGS**

**149**

**Detectamet**



# Metal Detectable Keyhole Loop Tags

FR: Étiquettes à boucle

ES: Etiquetas en espiral o en forma de cerradura

DE: Anhängetiketten mit integrierter Anhängeschlaufe/Schlaufenetiketten

This wide range of keyhole loop tags is available in eleven colours, two sizes, with/without printed text and in three different heat strengths, making them suitable for a wide range of applications.



In Partnership with  
**BRCGS**  
 150  
**detectamet**

## Features and benefits

**LARGE**

279mm (10.98")

48mm (1.88")

**SMALL**

190mm (7.48")

25mm (0.98")

**BESPOKE SIZES AVAILABLE**

- MATERIAL SPECIFICATION:**

Standard material:  
Heat resistant to 150°C/302°F

High heat material:  
Heat resistant to 250°C/482°F

Super high heat material:  
Heat resistant to 300°C/572°F
- BESPOKE PRINTING**

We can print our tags with your information. *Subject to MOQ.*

Please talk to a sales representative for more details.



AVAILABLE IN 11 DIFFERENT COLOURS:

**PRODUCT CODE: 555-P01**

# Metal & X-Ray Detectable Stainless Steel Loop Tag Dispenser

**FR:** Distributeurs d'étiquettes à boucle en acier inoxydable

**ES:** Expendedor de etiquetas en espiral o en forma de cerradura de acero inoxidable

**DE:** Edelstahlspender für Anhängetiketten mit integrierter Anhängeschlaufe/Schlaufenetiketten

This 304 grade stainless steel keyhole and loop tag dispenser is wall mountable and can accommodate single or multiple rolls of either large or small keyhole tags.

## Features & Options

1  
PACK

FILL LEVEL  
INDICATOR

REUSABLE

WALL  
MOUNTABLE

SUITABLE  
FOR LASER  
ENGRAVING

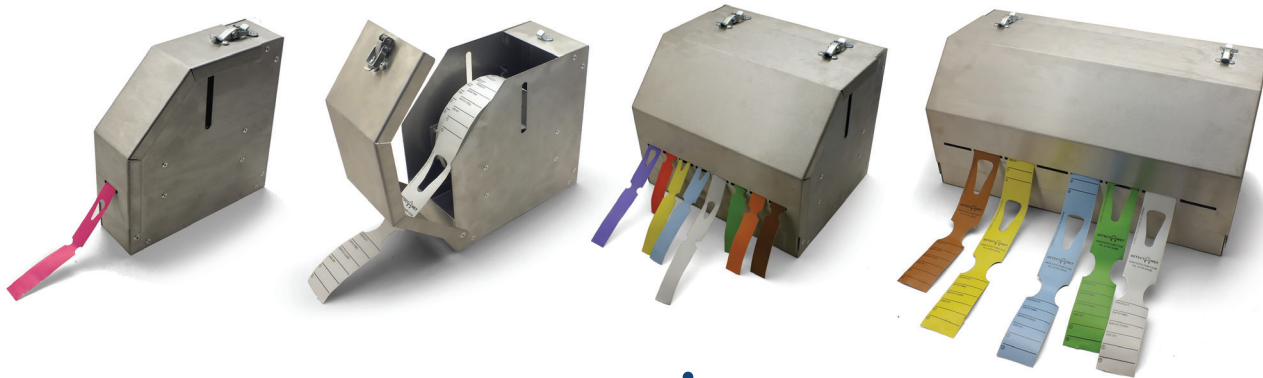

HOLDS 8 ROLLS OF SINGLE OR  
MULTIPLE KEYHOLE TAGS

### SIZES:

single (1 roll) small tag 82 x 300 x 302 mm (3.22 x 11.81 x 11.88")

single (1 roll) large tag 110 x 300 x 302 mm (4.33 x 11.81 x 11.88")

multiple (up to 8 rolls) small tag 278 x 300 x 302 mm (10.94 x 11.81 x 11.88")

multiple (up to 8 rolls) large tag 489 x 300 x 302 mm (19.25 x 11.81 x 11.88")

COLOUR: 

PRODUCT CODE: 558-S176

In Partnership  
with  
**BREGS**

151

**Detectamet**

## Metal Detectable Reusable / Releasable Nylon Cable Ties

FR: Attaches de câble en nylon desserrables et réutilisables  
 ES: Precintos de nailon desprendibles y reutilizables  
 DE: Wiederverwendbare, lösbare Nylonkabelbinder

Our intelligent, reusable cable tie features a release lever that allows the tie to be used again and again.

ENVIRONMENTALLY FRIENDLY



100 PACK

COST EFFECTIVE

REUSABLE / RELEASABLE

PRODUCT CODE	SIZE	TENSILE STRENGTH
800-CT02-1231-X11	250 x 7.5 mm (9.84 x 0.29")	280 N (63 lb)

Colour: ■

ENVIRONMENTALLY FRIENDLY

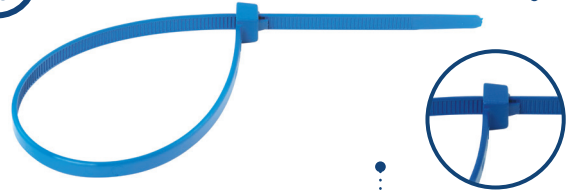

100 PACK

COST EFFECTIVE

REUSABLE / RELEASABLE

PRODUCT CODE	SIZE	TENSILE STRENGTH
800-CT02-S120-X39	250 x 4.8 mm (9.84 x 0.18")	225 N (50 lb)

Colour: ■

PRODUCT CODE: 800-CT02-S120-X39 & 800-CT02-1231-X11

Sequential numbering available for all products • Ask us for a pen and knife guide

## Metal Detectable Nylon Cable Ties

FR: Attaches de câble en nylon  
 ES: Precintos de nailon  
 DE: Kabelbinder aus Nylon

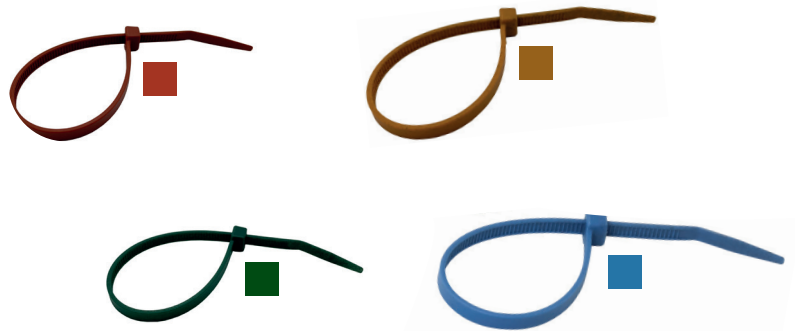

These detectable nylon cable ties, available in a range of different sizes and colours, are specifically designed for the food industry.

### Features & Options

100 PACK

Colour	SIZE	TENSILE STRENGTH
<span style="color: blue;">■</span>	92 x 2.4 mm (3.62 x 0.09")	80 N (18 lb)
<span style="color: blue;">■</span> <span style="color: red;">■</span> <span style="color: green;">■</span> <span style="color: brown;">■</span>	145 x 3.4 mm (5.70 x 0.13")	80 N (18 lb)
<span style="color: blue;">■</span>	150 x 3.5 mm (5.90 x 0.13")	135 N (30 lb)
<span style="color: blue;">■</span> <span style="color: red;">■</span> <span style="color: green;">■</span> <span style="color: brown;">■</span>	185 x 4.6 mm (7.28 x 0.18")	80 N (18 lb)
<span style="color: blue;">■</span>	200 x 4.6 mm (7.87 x 0.18")	225 N (50 lb)
<span style="color: blue;">■</span>	380 x 4.7 mm (14.96 x 0.18")	80 N (18 lb)
<span style="color: blue;">■</span>	390 x 7.6 mm (15.35 x 0.29")	535 N (120 lb)
<span style="color: blue;">■</span> <span style="color: red;">■</span> <span style="color: green;">■</span> <span style="color: brown;">■</span>	390 x 4.6 mm (15.35 x 0.18")	225 N (50 lb)

Colours: ■ available in all sizes

■ ■ ■ only available in 145 x 3.4mm, 185 x 4.6mm & 390 x 4.6mm

PRODUCT CODE: 800-CTO

## Metal Detectable Economy Nylon Cable Ties

FR: Attaches de câble en nylon économiques détectables en métal

ES: Bridas de nailon económicas con detección de metales

DE: Metalldetektierbare Wirtschaft Nylon-Kabelbinder

Our Economy Nylon Cable Ties are perfect for food processing environments. Made from metal detectable polymer, these are available in an assortment of sizes.

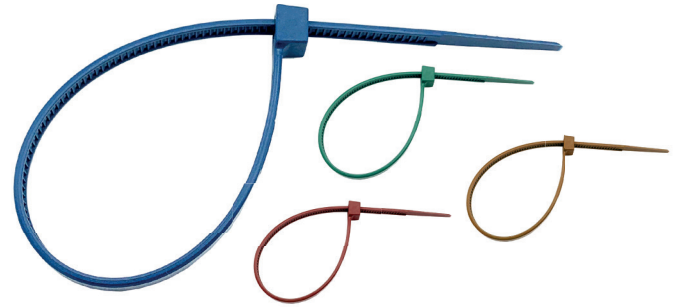

### Features & Options



PRODUCT CODE	SIZE	NYLON TENSILE STRENGTH
800-CT03-1229-X11	Cable Ties Nylon 250 x 4.5 mm (9.84 x 0.17")	200 N (44 lb)
800-CT03-1230-X11	Cable Ties Nylon 280 x 4.5 mm (11.02 X 0.17")	200 N (44 lb)
800-CT03-1232-X11	Cable Ties Nylon 140 x 3.5mm (5.51 x 0.13")	160 N (36 lb)
800-CT03-1233-X11	Cable Ties Nylon 180 x 4.5 mm (7.08 x 0.17")	200 N (44 lb)
800-CT03-1234-X11	Cable Ties Nylon 200 x 4.5 mm (7.87 x 0.17")	200 N (44 lb)
800-CT03-1235-X11	Cable Ties Nylon 380 x 4.5 mm (14.96 x 0.17")	200 N (44 lb)
800-CT03-1236-X11	Cable Ties Nylon 360 x 7.5 mm (14.17 x 0.29")	500 N (112 1/2 lb)
800-CT03-1237-X11	Cable Ties Nylon 100 x 2.5mm (3.93 x 0.09")	80 N (17 lb)

Colour:    

PRODUCT CODE: 800-CT03

More product codes available – please contact us for a full price list

## Metal Detectable Partially X-Ray Visible Polypropylene & Nylon Cable Ties with Stainless Steel Lock

FR: Attaches de câble en polypropylène et nylon à dispositif de blocage en acier inoxydable

ES: Precintos de polipropileno y nailon con cierre de acero inoxidable

DE: Kabelbinder aus Polypropylen und Nylon mit Edelstahlverschluss

These blue polypropylene & nylon cable ties have a stainless steel lock and come in four different sizes.



STRONG STAINLESS STEEL LOCK



SIZE	POLYPROPYLENE TENSILE STRENGTH
92 x 2.4 mm (3.62 x 0.09")	50 N (11 lb)
186 x 4.8 mm (7.32 x 0.18")	130 N (29 lb)
340 x 7 mm (13.38 x 0.27")	270N (60 1/2 lb)
360 x 4.8 mm (14.17 x 0.18")	130 N (29 lb)

SIZE	NYLON TENSILE STRENGTH
92 x 2.4 mm (3.62 x 0.09")	80 N (18 lb)
186 x 4.8 mm (7.32 x 0.18")	180 N (40 1/2 lb)
340 x 7 mm (13.38 x 0.27")	540 N (121 lb)
360 x 4.8 mm (14.17 x 0.18")	220N (49 1/2 lb)



BUOYANT - SUITABLE FOR USE WITH LIQUIDS

Colour: 

PRODUCT CODE: 800-CT01-S1 (Nylon), 800-CT08-S1 (Polypropylene)



## Metal Detectable Cable Tie Mounts

FR: Fixations de câble  
 ES: Precintos montables  
 DE: Befestigungsanker

10  
PACK

These detectable cable tie mounts come in two sizes, can be screwed to walls & surfaces to hold cable ties in place and are suitable for use in the food industry.

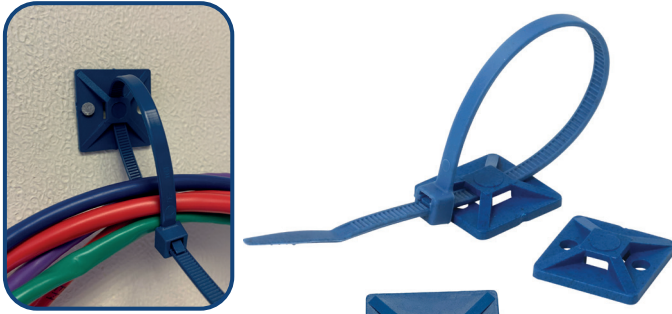

### Features & Options

- Metal detectable
- Two screw holes
- Sizes:  
 28 x 28 mm (1.10 x 1.10")  
 19 x 19 mm (0.74 x 0.74")

Colour: ■

**PRODUCT CODE:** 808-S036-X11, 808-S037-X11

## Metal Detectable Cable Identification Tags

FR: Système d'identification de câble  
 ES: Sistema de identificación de cables  
 DE: Kabelkennungssystem

190  
PACK

These cable identification tags are available in two types, one to write/print on, or one customisable with attachable characters.



### Features & Options

- Metal detectable
- Secure using detectable cable ties
- Attachable characters (available on request)
- Sizes:  
 42 x 9.5 mm (1.65 x 0.37")  
 62 x 9.5 mm (2.44 x 0.37")  
 122 x 9.5 mm (4.80 x 0.37")

Colour: ■

**PRODUCT CODE:** 797-CT04-S664-X54

Sequential numbering available for all products • Ask us for a pen and knife guide

## Metal Detectable Cable Organiser

FR: Range-câble en spirale  
 ES: Envoltorio para cables en espiral  
 DE: Spiralwicklung / Kabelband

1  
PACK

This spiral detectable cable organiser comes in three different diameters and is designed to keep cables together within a food factory environment.



### Features & Options

- Metal detectable
- Sizes:  
 dia. 4, 9 & 16 mm (0.15, 0.35 & 0.62")  
 length 3 m (94")

Colour: ■

**PRODUCT CODE:** 803-S22

## Metal Detectable & X-Ray Visible 'Detect-A-Clamp' Cable Clamps

FR: Serre-câbles  
 ES: Sujetacables  
 DE: Kabelschellen

2  
PACK

These detectable cable clamps come in two sizes and are reusable, making them perfect for organising cables in food processing areas.



### Features & Options

- Metal detectable
- X-Ray visible
- Reusable
- Sizes:  
 small - secures bundles  
 11 - 29 mm (0.43 - 1.14")  
 large - secures bundles  
 23 - 50 mm (0.90 - 1.96")

Colour: ■

**PRODUCT CODE:** 802-S089-T020, 802-S089-T020

# Metal Detectable & X-Ray Visible Tags, Labels & Seals

## Metal Detectable and X-Ray Visible Security Seals

100  
PACK

**SEQUENTIAL NUMBERING AVAILABLE**  
(MOQ and additional charge applies)

FR: Joint de sécurité  
ES: Sello de seguridad  
DE: Sicherheitsband

These detectable "pull tight" seals are manufactured from polypropylene containing a metal additive, allowing any part to be detected by conventional detection equipment if it enters the food chain.

### SIZES:

small - tag head 46 x 17mm (1.81 x 0.66")  
ribbon lengths 126 or 228mm (4.96 or 8.97")  
large - tag head 39 x 31mm (1.53 x 1.22")  
ribbon lengths 265 or 360mm (10.43 or 14.17")

Colours: 

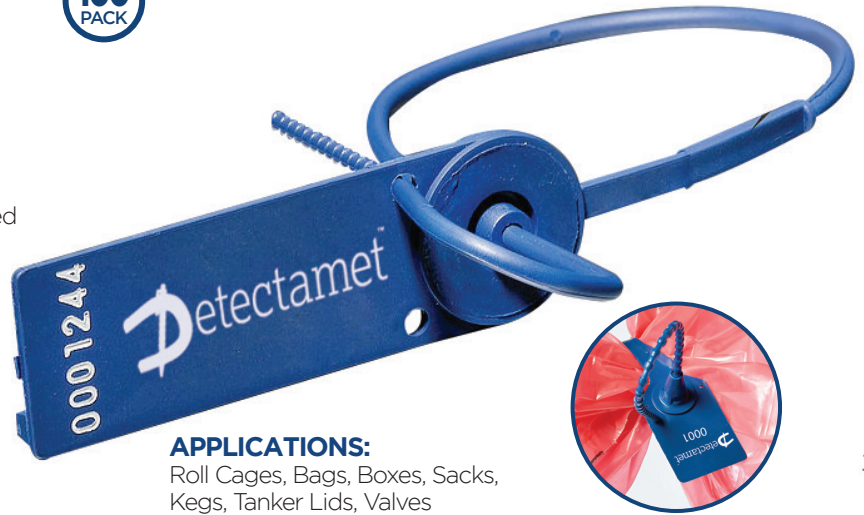

### APPLICATIONS:

Roll Cages, Bags, Boxes, Sacks,  
Kegs, Tanker Lids, Valves

**PRODUCT CODE:** 847

More product codes available - please contact us for a full price list

## Metal & X-Ray Detectable 'Easy Tear' Security Seals

FR: Joint de sécurité  
ES: Sello de seguridad  
DE: Sicherheitsband

100  
PACK

**Made In:**  
**UK** 

These detectable "pull tight" seals are manufactured from polypropylene containing a metal additive, allowing any part to be detected by conventional detection equipment if it enters the food chain.

New  
Product!



### SIZES:

Tag head 60 x 13 mm (2.36 x 0.51")  
ribbon lengths 126 or 228 mm (4.96 or 8.97")

New  
Product!



### SIZES:

Tag head 63 x 30 mm (2.48 x 1.18")  
ribbon lengths 265 or 360mm  
(10.43 or 14.17")

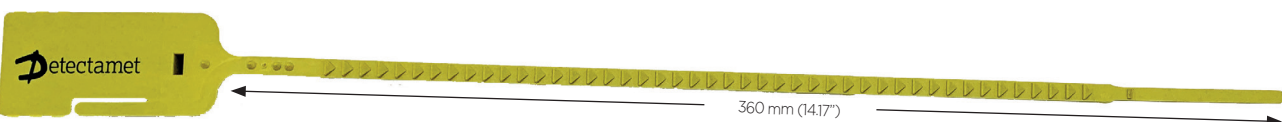
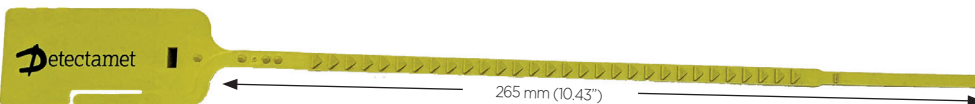

### APPLICATIONS:

Roll Cages, Bags, Boxes,  
Sacks, Kegs, Tanker  
Lids, Valves



### EASY TEAR:

These one-piece detectable plastic pull through security seals also feature a tear-line for easy removal of the seal without the use of any tools.

Colours:    

Additional Colours (subject to MOQ):    

**PRODUCT CODE:** 847

In Partnership  
with

**BROGS**

155

**Detectamet**

# Metal & X-Ray Detectable 'Easy Tear' Security Seals with Sequential Numbering

FR: Joint de sécurité

ES: Sello de seguridad

DE: Sicherheitsband

New  
Product!

Made In:  
UK 

These detectable "pull tight" seals are manufactured from polypropylene containing a metal additive, allowing any part to be detected by conventional detection equipment if it enters the food chain.

## SEQUENTIALLY NUMBERED:

Security Seals are sequentially numbered from 1625000 to 1634999. Sold in packs of 100.

## Features and benefits

100  
Pack

### SIZES:

Tag head 60 x 13 mm (2.36 x 0.51")  
Ribbon length 228 mm (8.97")

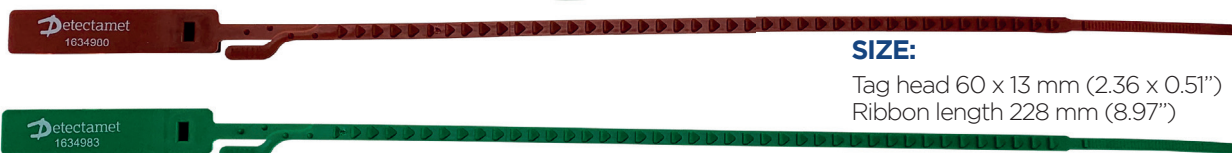

### SIZE:

Tag head 60 x 13 mm (2.36 x 0.51")  
Ribbon length 228 mm (8.97")

### SIZE:

Tag head 60 x 13 mm (2.36 x 0.51")  
Ribbon length 126 mm (4.96")



### SIZES:

Tag head 60 x 13 mm (2.36 x 0.51")  
Ribbon length 126 mm (4.96")



Colours:   

PRODUCT CODE: 847B



# Metal Detectable & X-Ray Visible Tags, Labels & Seals

## Metal Detectable & X-Ray Visible Circular Identification Tags

FR: Étiquettes d'identification en plastique

ES: Etiquetas identificativas plásticas

DE: Kreisförmige Erkennungsmarken

10  
PACK

Made In:  
UK USA

These circular ID tags are available in two sizes and nine colours, making them perfect as an identifier or where warnings are required.

### SIZES:

small 85 mm (3.34") dia. x 2.8 mm (0.11") thickness

large 110 mm (4.33") dia. x 2.8 mm (0.11") thickness

SPLIT RING  
AVAILABLE AT  
ADDITIONAL  
CHARGE

SUITABLE FOR PAD  
PRINTING/LASER  
ENGRAVING



BESPOKE  
SIZES AVAILABLE

PRE-DRILLED  
HOLE

Colours:

PRODUCT CODE: 213-PO

## Metal Detectable & X-Ray Visible Identification Tags

FR: Étiquettes de traçabilité

ES: Etiquetas de trazabilidad

DE: Nachverfolgbare Etiketten

Made In:  
UK

Metal detectable ID tags available in nine colours, suitable for a wide range of applications in the food industry.

PRE-DRILLED  
HOLE

SUITABLE FOR PAD  
PRINTING/LASER  
ENGRAVING



### SIZES:

small 25 x 55 x 1.6 mm (0.98 x 2.16 x 0.06")

large 70 x 60 x 1.6 mm (2.75 x 2.36 x 0.06")

Colours:

PRODUCT CODE: 205-A65

In Partnership  
with  
**BROGS**

Sequential numbering available for all products • Ask us for a pen and knife guide

## Metal Detectable & X-Ray Visible Looped ID Tags

FR: Étiquettes plastiques réutilisables

ES: Etiquetas plásticas reutilizables

DE: Wiederverwendbare Plastiketiketten

25  
PACK

Made In:  
UK

These reusable tags are available in nine different colours and are suitable for numerous uses, including tagging of machinery.

REUSABLE



### SIZES:

length 283 mm (11.14")

head 63 x 87 mm  
(2.48 x 3.42")

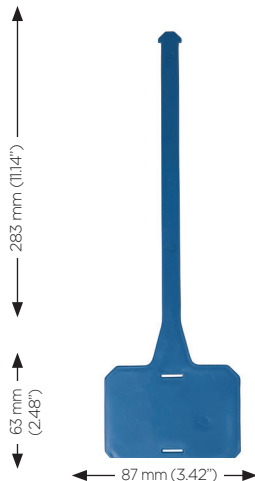

Colours:

PRODUCT CODE: 550

## Metal Detectable & X-Ray Visible ID & Lockout Tags

FR: Étiquette de verrouillage avec identification

ES: Etiqueta identificativa de cierre

DE: Absperrungs- und Kennzeichnungsetikett

10  
PACK

Made In:  
UK USA

These reusable tags are available in nine different colours and are perfect for where a warning is required.

REUSABLE

SUITABLE FOR PAD  
PRINTING/LASER  
ENGRAVING



### SIZES:

70 x 123 x 2.8 mm  
(2.75 x 4.84 x 0.11")

WITH/WITHOUT  
LOCKOUT  
GRAPHIC

Colours:

PRODUCT CODE: 213

**Detectamet**

157



# Bespoke Shadow & Management Boards

FR: Panneau porte-outil  
ES: Tablero de herramientas  
DE: Shadow Board



In Partnership  
with  
**BRCGS**

158

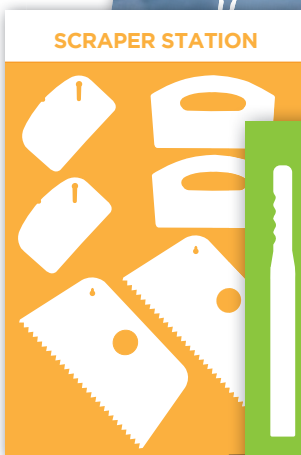
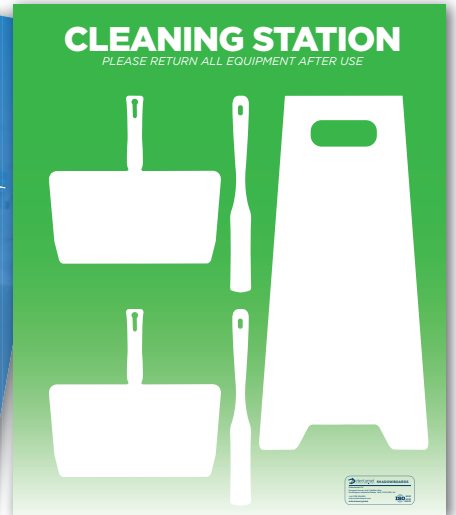
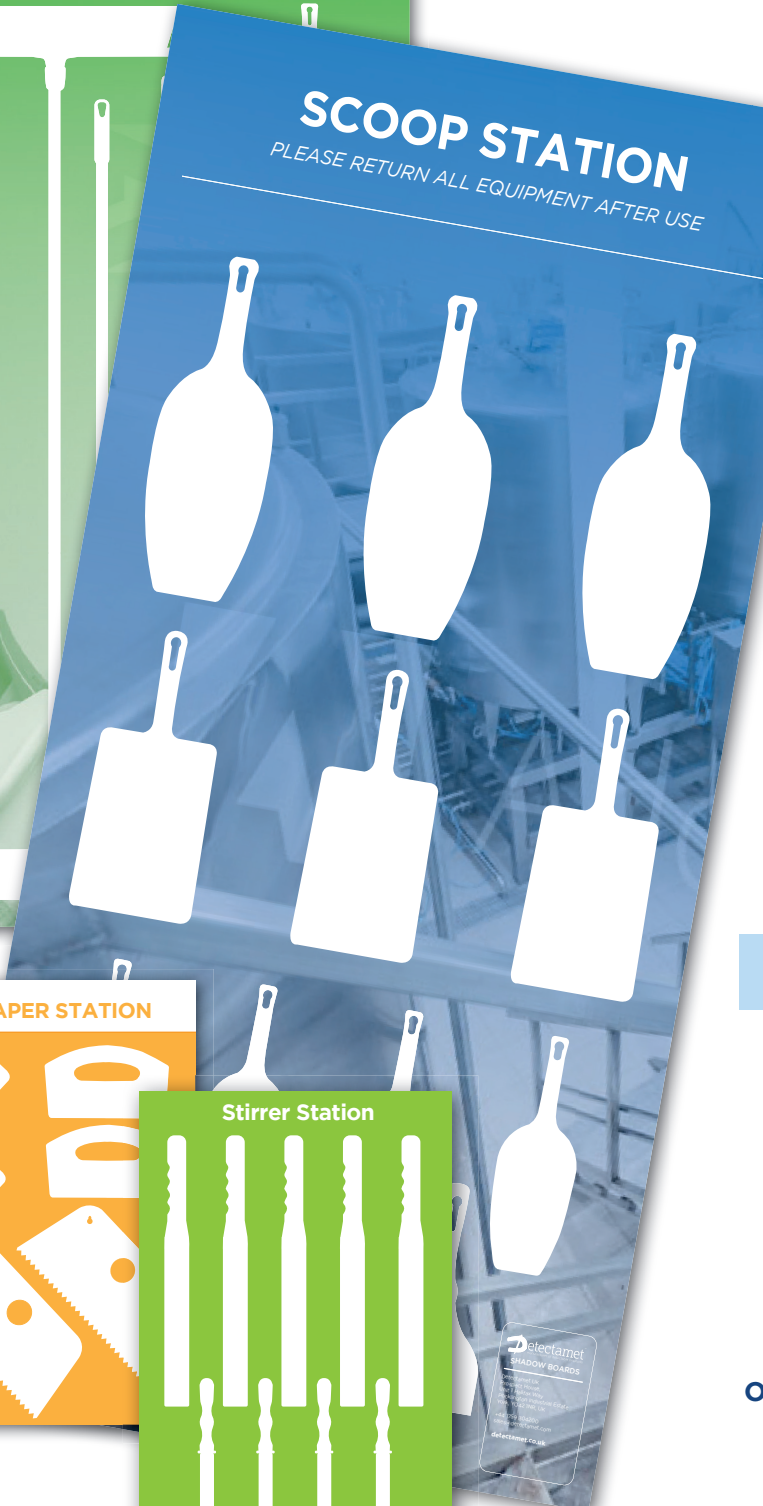

Management tool for clear team communication and organisation. Ideal for safe and efficient tool storage and incorporates Kaizen and 5S principles to assist with food safety management audits.

## Features & Options

**BESPOKE SIZES AVAILABLE**

**REDUCES RISK OF CROSS CONTAMINATION**

**QUICKLY IDENTIFY MISSING ITEMS**

**COMPLETELY CUSTOMISABLE**

**SUPPLIED WITH STAINLESS STEEL OR DETECTABLE PLASTIC FITTINGS. PURPOSE BUILT HOLDERS FOR HANGING & SECURING TOOLS**

**SOLD INDIVIDUALLY**

**PRODUCT CODE: 931**

**Detectamet**

# Why Use Detectamet Shadow Boards

- Reduce the risk of missing equipment and interruptions to production.
- Use clear graphics to efficiently communicate messages with staff.
- Decrease production costs by saving time and reducing production re-works.
- Minimise tool & equipment costs by clearly identifying non-returned items.

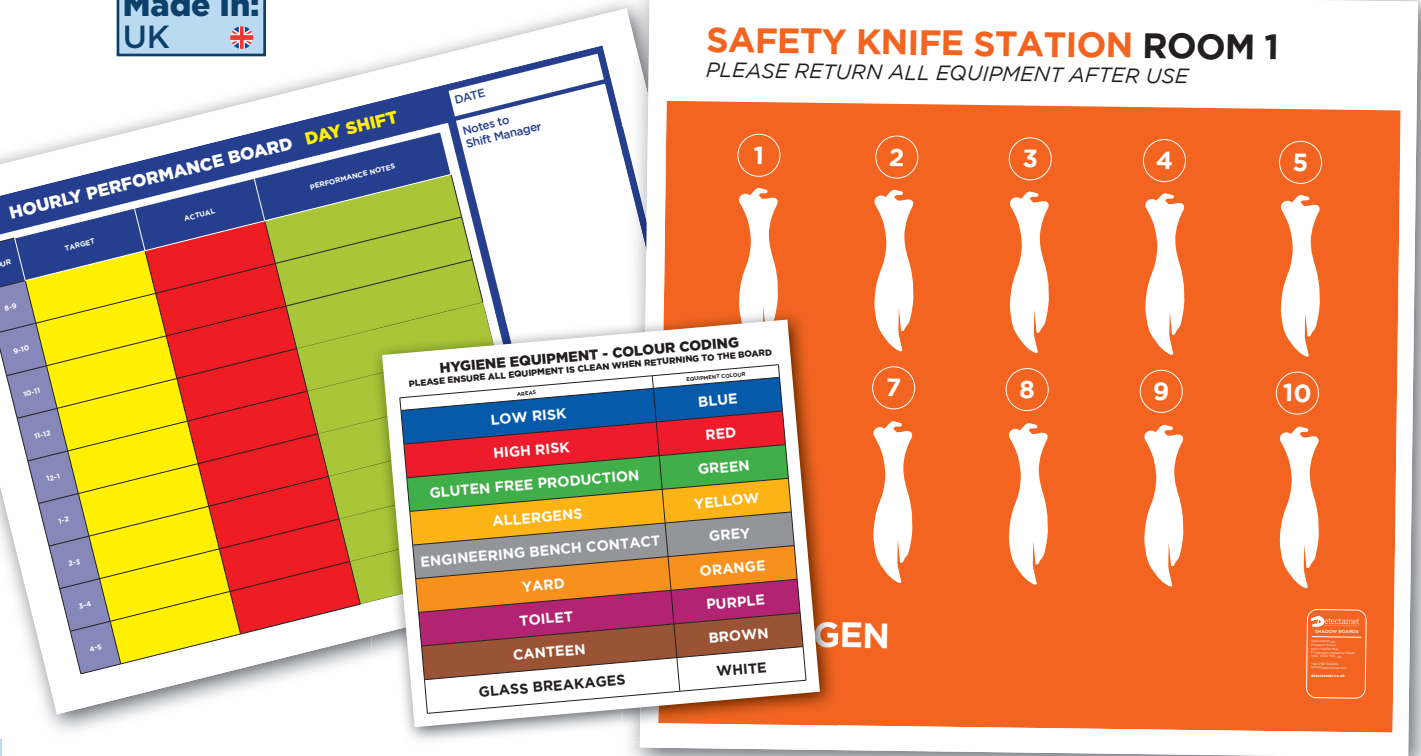

In Partnership with  
**BROGS**

159

## Our 6 Step Ordering Process

Enquiry



Please specify colour, size, featured products and any additional information / requirements for your board.

Quotation



Your quotation for your board will be sent back to you within one working day.

Order



Once you are happy with the quotation and we have received all information, we can now proceed to order.

Proofing



Once the artwork proofs are available, we will ask for your artwork to be proofed & signed off.

Production



Our in-house production team will complete your order in the time agreed.

Delivery



Once production is completed your board will be carefully delivered to your site.

PRODUCT CODE: 931

**detectamet**

## Shadow & Management Board Accessories

Our shadow board accessories are perfect for hanging a variety of products to our shadow boards. **For more information, please contact your local Detectamet branch.**

### Metal Detectable & X-Ray Visible Dispensers

FR: Distributeurs  
ES: Dispensadores  
DE: Spender



A great variety of our 'wall-mountable' dispensers are perfect for attaching to our shadow boards. Please contact your local sales representative for more information.



Colours:

Shadow Board Accessories

### Metal Detectable & X-Ray Visible Utility Hooks

FR: Crochets utilitaires  
ES: Ganchos de utilidad  
DE: Utility-Hooks



**FULLY METAL & X-RAY DETECTABLE UTILITY HOOKS**



Colours:

**STAINLESS STEEL UTILITY HOOKS**



Colour:

**PRODUCT CODE: 136 & 137**

Shadow Board Accessories

### Shadow Board Accessories

FR: Accessoires de tableau d'ombre  
ES: Accesorios de tablero de sombra  
DE: Zubehör für Schattenbretter

These rail & wall-mountable shadow board accessories are the perfect way to keep items organised and secure. Available in a great range of styles, sizes & colours.

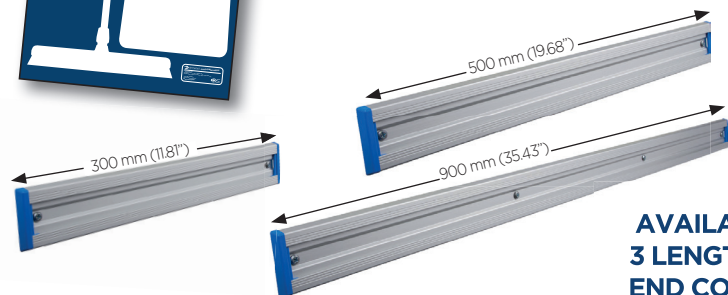

**RAILS AVAILABLE IN 3 LENGTHS & 6 END COLOURS**

### Handle Grippers

**(PRODUCT CODE: 931G)**

Available in 4 sizes and 6 colours. Perfect for gripping a variety of handheld items.

Gripping Sizes:

- Small: Tools 15 to 20 mm (0.59 to 0.78")
- Medium: Tools 20 to 30 mm (0.78 to 1.18")
- Large: Tools 25 to 35 mm (0.98 to 1.37")
- X-Large: Tools 30 to 40 mm (1.18 to 1.57")

Colours:

**RUBBER GRIP CLASPS HANDLES**

### Universal Holder

**(PRODUCT CODE: 931U)**

Available in black. Perfect for holding a variety of items. Maximum weight 10 kg.

Colours:

### Hook

**(PRODUCT CODE: 931H)**

Available in 6 colours. Perfect for holding a variety of smaller items. Maximum weight 3 kg.

Colours:

### Bucket Holder

**(PRODUCT CODE: 931B)**

Available in black. Maximum weight 10 kg.

Colours:

# Metal Detectable & X-Ray Visible Safety Knives & Locking Knives



**FR:** Couteaux de sécurité

**ES:** Cuchillos de seguridad

**DE:** Sicherheitsmesser

161

## Safety Knives

Safety Knife Applications	162
Replacement Blades	163
Safety Knife Features	163
Disposable Light Duty Safety Knives	164
Disposable Light Duty Safety Knives with Hook Blade	164
Disposable Heavy Duty Safety Knives with Enclosed Blades and Tape Cutter	165
Disposable Normal Duty Bag Cutters with Enclosed Blade	165
Disposable Light Duty Safety Knives with Dual Enclosed Blades	166
Disposable Normal Duty Safety Knives with Enclosed Blade and Hook Blade	166
Disposable Light Duty Safety Knives with Enclosed Blade and Tape Cutter	167
Disposable Light Duty Plastic Sheet Cutters with Enclosed Blade	167
Disposable Light Duty Safety Knives with Enclosed Blade	168
Disposable Light Duty Ring Safety Knives	168
Normal Duty Safety Knife	169
Normal Duty Safety Knife with Enclosed Blade and Tape Cutter	169

Normal Duty Safety Knives 170

Normal Duty Safety Knives with Dual Enclosed Blades and Tape Cutter 170

Normal Duty Stainless Steel Safety Knife with Auto Retracting Blade 170

Heavy Duty Aluminium Safety Knife 171

Heavy Duty Detectable Safety Knife 172

Heavy Duty Detectable Steel Safety Knife with Enclosed Blade 172

Heavy Duty Detectable Safety Knives with Enclosed Blade 173

Heavy Duty Detectable Box Cutter 173

## Locking Knives

Lambfoot Blade 174

Sheepfoot Blade 174

Clip Point Blade 174

Pruning Blade 175

All Purpose Blade 175

Pruning Blade 175

Drop Point Blade 175





# Knife Applications

	Replacement Blades	Cardboard	Plastic Wrapping	Sacks/Plastic Bags	Plastic Netting	Plastic Adhesive Tape	Bubble Wrap	Plastic Strapping	Retractable
Disposable, Light Duty Safety Knives <b>615-K104-T184-P01 - Page 164</b>		✓	✓			✓			✓
Disposable, Light Duty Safety Knives Hook Blade <b>615-K108-T194-P01 - Page 164</b>		✓	✓			✓	✓	✓	
Disposable, Heavy Duty Safety Knives with Enclosed Blades and Tape Cutter <b>615-K107-T031-P0 - Page 165</b>		✓	✓	✓	✓	✓	✓	✓	
Disposable, Light Duty Bag Cutters with Enclosed Blade <b>615-K116-T035-P01 - Page 165</b>		✓	✓	✓	✓	✓	✓	✓	
Disposable, Normal Duty Safety Knives with Dual Enclosed Blades <b>615-K122-T184-P01 - Page 166</b>		✓	✓	✓	✓	✓		✓	
Disposable, Normal Duty Safety Knives - Enclosed Blade & Hook Blade <b>615-K117-T196-P01 - Page 166</b>		✓	✓		✓	✓	✓	✓	
Disposable, Light Duty Safety Knives - Enclosed Blade & Tape Cutter <b>615-K127-T538-P01 - Page 167</b>			✓	✓		✓		✓	
Disposable, Light Duty Plastic Sheet Cutters with Enclosed Blade <b>615-K121-T184-P01 - Page 167</b>			✓			✓			
Disposable, Light Duty Safety Knives with Enclosed Blade <b>615-K106-T030-P0 - Page 168</b>			✓	✓	✓		✓	✓	
Disposable, Light Duty Ring Safety Knives <b>615-K123-T184-P01 - Page 168</b>			✓						
Normal Duty Safety Knife <b>615R-K119-T037-A117 - Page 169</b>	✓	✓	✓	✓	✓	✓	✓	✓	✓
Normal Duty Safety Knife with Enclosed Blade and Tape Cutter <b>615-K126-T184-P01 - Page 169</b>	✓	✓	✓	✓		✓		✓	
Normal Duty Safety Knives <b>615-K124-T184-P01 - Page 170</b>	✓	✓	✓	✓		✓		✓	✓
Normal Duty Safety Knives with Dual Enclosed Blades and Tape Cutter <b>615-K115-T132-P01 - Page 170</b>		✓	✓	✓	✓	✓	✓	✓	
Normal Duty Stainless Steel Safety Knife with Auto Retracting Blade <b>615-K125-T513-P45 - Page 171</b>	✓	✓	✓	✓	✓				✓
Heavy Duty Aluminium Safety Knife <b>615-K102-T038-P30 - Page 171</b>	✓	✓	✓	✓	✓	✓	✓	✓	✓
Heavy Duty Detectable Safety Knife <b>615R-K120-T037-A118 - Page 172</b>	✓	✓	✓	✓	✓	✓	✓	✓	✓
Heavy Duty Detectable Safety Knife with Enclosed Blade <b>615-K118-T197-P01 - Page 172</b>	✓	✓	✓		✓	✓	✓	✓	
Heavy Duty Detectable Safety Knives with Enclosed Blade <b>615-K109-T195-P01 - Page 173</b>	✓	✓	✓		✓	✓	✓	✓	
Heavy Duty Detectable Box Cutter <b>615-K112-T034-P27 - Page 173</b>	✓	✓	✓		✓	✓	✓	✓	✓

# Detectable Safety Knife Features

Ensure you choose the correct knife for your requirements by consulting the Safety Knife Features outlined below and listed on each product description.



### Replacement Blades Available

We offer replacement blades for many of our safety knives.



### Cardboard

Suitable for cutting through cardboard packaging. For consistent cutting of thicker cardboard, we recommend our Heavy Duty Knife Range.



### Plastic Strapping

Suitable for cutting through plastic strapping, usually found wrapped around cardboard boxes.

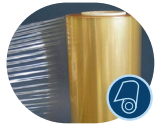

### Plastic Wrapping

Suitable for cutting through plastic wrapping.



### Sacks/Plastic Bags

Suitable for cutting through plastic sacks and bags.

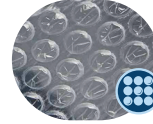

### Bubble Wrap

Suitable for cutting through bubble wrap.

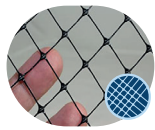

### Plastic Netting

Suitable for cutting through plastic netting.



### Plastic Adhesive Tape

Suitable for cutting through plastic adhesive tape.



### Retractable Blade

Some of our detectable knives are retractable for added safety.

**Disposable Knives:** Safety knives with a non-replaceable blade.

**Light Duty Knife Range:** A lighter duty knife, capable of cutting thin plastics and card.

**Normal Duty Knife Range:** A longer-lasting knife, capable of cutting a variety of products, from lighter materials to thicker plastics and card.

**Heavy Duty Knife Range:** Our longest lasting range of knives, resilient to consistent cutting of thicker packaging, including heavy duty cardboard.

## Replacement Blades

DESCRIPTION	PACK SIZE	PRODUCT CODE
SK102 Trapezoid blades	10	618-P32-K005-T073
SK119 Trapezoid blades	10	618-P32-K005-T388
SK119 Rounded blades	10	618-P32-K007-T388
SK119 Hook blades	10	618-P45-K119-T197
SK120 Trapezoid blades	10	618-P32-K005-T388
SK118 Straight blades	10	618-P32-K002-T387
SK109 Straight blades	10	618-P32-K002-T075
SK109 Hook blades	10	618-P32-K001-T075
SK126 Straight blades	10	618-P32-K003-T530
SK124 Straight blades	10	618-P32-K002-T520
SK112 Straight blades	10	618-P32-K002-T077
SK111 Hook blades	10	618-P40-K001-T076
SK125 Trapezoid blades	10	618-P32-K005-T514

## Disposable, Light Duty Metal Detectable Safety Knives with Auto Retracting Blade

FR: Couteau de sécurité à lame jetable  
 ES: Navaja de seguridad con hoja desechable  
 DE: Sicherheitsmesser mit Einwegklinge

These detectable disposable safety knives are light and compact in shape and ideal for cutting packaging.

**Best Seller!**

SUITABLE FOR LASER ENGRAVING

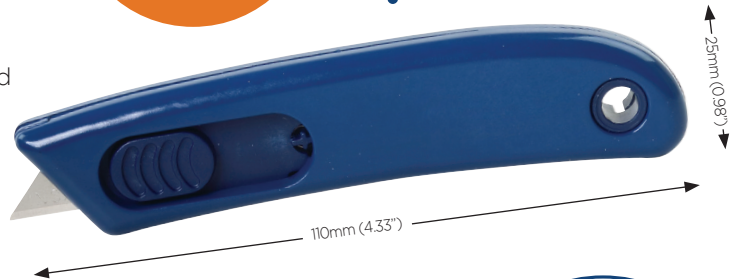

### Features & Options

5 PACK

Made In: UK

Colour: ■



STAINLESS STEEL BLADE

AUTOMATIC BLADE RETRACTION



PRODUCT CODE: 615-K104-T184-PO1

More product codes available – please contact us for a full price list

## Disposable, Light Duty Metal Detectable Safety Knives with Hook Blade

FR: Couteau de sécurité multi-usage  
 ES: Navaja de seguridad multifunción  
 DE: Mehrzweck-Sicherheitsmesser

These disposable, lightweight detectable safety knives have an enclosed blade, optional hook and tape cutter and are suitable for light use.

SUITABLE FOR AMBIDEXTROUS USE

LANYARD POINT

ONE-PIECE

**Best Seller!**

5 PACK



ENCLOSED STAINLESS STEEL BLADE

SUITABLE FOR LASER ENGRAVING



HOOK (T194)

CUTTER (T193)

STANDARD (T192)

Colours: ■ ■ ■ ■



PRODUCT CODE: 615-K108-T194-PO1

## Disposable, Heavy Duty Metal Detectable Safety Knives with Enclosed Blades and Tape Cutter

FR: Cutter pour emballage robuste

ES: Cortador de envoltorios de alta resistencia

DE: Kraftschneidwerkzeug

These disposable, heavy duty detectable safety knives have enclosed blades and a tape cutter on the end and are suitable for all packaging use.

### Features & Options

5  
PACK

Made In:  
UK 

Colours: 



PRODUCT CODE: 615-K107-T031-P0

Sequential numbering available for all products

OPPOSING SLOPES ON KNIFE HEAD REDUCE FRICTION FOR A MORE EFFICIENT CUT

SUITABLE FOR LASER ENGRAVING



ENCLOSED STAINLESS STEEL BLADES

SUITABLE FOR AMBIDEXTROUS USE

ONE-PIECE

LANYARD POINT

## Disposable, Normal Duty Metal Detectable Bag Cutters with Enclosed Blade

FR: Cutter à sac

ES: Cortador de bolsas en forma de cisne

DE: Tütenschneider in Schwanform

These disposable, detectable bag cutters have an additional tape cutter and the pointed nose punctures material, making them great for general warehouse use.

### Features & Options

5  
PACK

Made In:  
UK 

Colour: 

Best  
Seller!



PRODUCT CODE: 615-K116-T035-P01

SUITABLE FOR AMBIDEXTROUS USE

OPPOSING SLOPES ON KNIFE HEAD REDUCE FRICTION FOR A MORE EFFICIENT CUT



ONE-PIECE

LANYARD POINT

SUITABLE FOR LASER ENGRAVING

ENCLOSED STAINLESS STEEL BLADE

In Partnership  
with

**BROGS**

165

etectamet



## Disposable, Light Duty Metal Detectable Safety Knives with Dual Enclosed Blades

FR: Couteau de sécurité compact à double lame  
 ES: Navaja de seguridad compacta de hoja doble  
 DE: Kompaktes Sicherheitsmesser mit Doppelklinge

These are economical, disposable detectable safety knives. With two cutting edges they last twice as long, reducing your plastic waste, and are suitable for many types of packaging.

### Features & Options

5  
PACK

Colour:



PRODUCT CODE: 615-K122-T184-P01

More product codes available – please contact us for a full price list

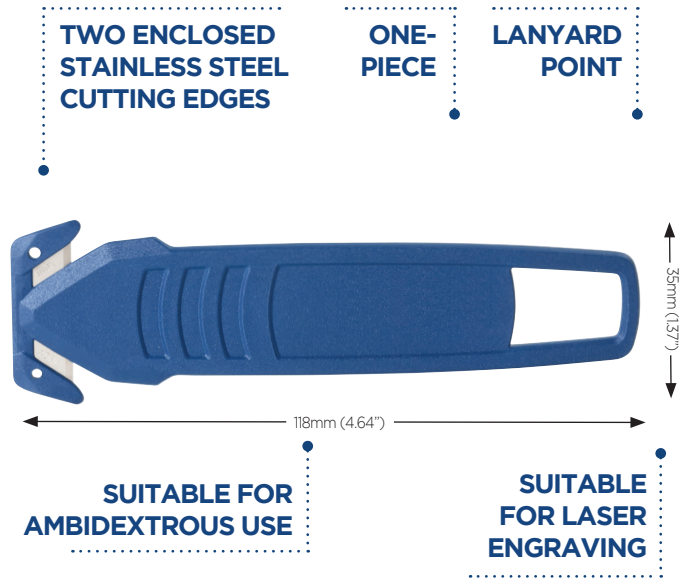

## Disposable, Normal Duty Metal Detectable Safety Knives with Enclosed Blade and Retractable Hook Blade

FR: Couteau de sécurité à lame crochet rétractable  
 ES: Navaja de seguridad con hoja en gancho retráctil  
 DE: Sicherheitsmesser mit einziehbarer Hakenklinge

These detectable, disposable safety knives come with an auto retracting hook blade and are suitable for plastic packaging and light cardboard use.

### Features & Options

5  
PACK

Colour:



OPPOSING SLOPES ON KNIFE HEAD REDUCE FRICTION FOR A MORE EFFICIENT CUT

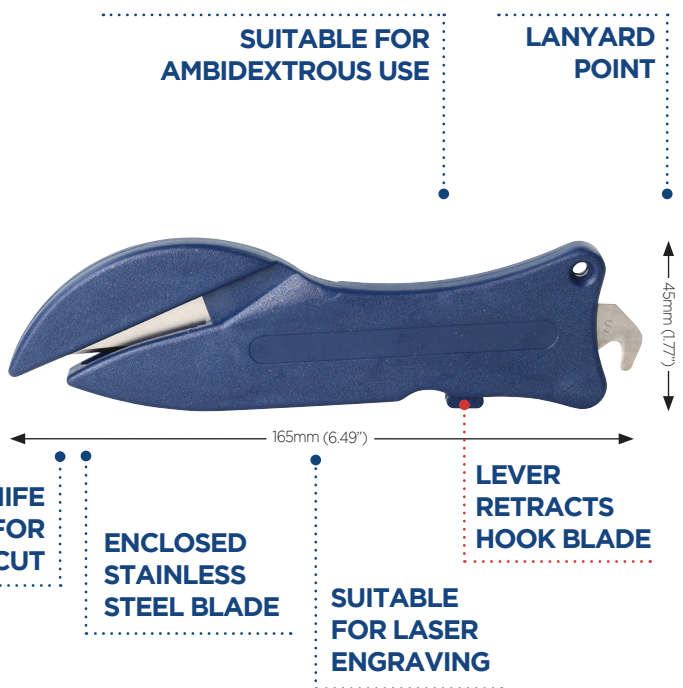

PRODUCT CODE: 615-K117-T196-P01

## Disposable, Light Duty Safety Knives with Enclosed Blade and Tape Cutter

**FR:** Couteau de sécurité avec protège-lame et coupe-ruban

**ES:** Navaja de seguridad con cortador de cinta y cuchilla cerrada

**DE:** Sicherheitsmesser mit abgedeckter Klinge und bandabschneider

These disposable detectable safety knives have an enclosed blade plus tape cutter and are suitable for all plastic packaging.

### Features & Options

5  
PACK

Colour:



**PRODUCT CODE:** 615-K127-T538-P01

Sequential numbering available for all products



## Disposable, Light Duty Metal Detectable Plastic Sheet Cutters with Enclosed Blade

**FR:** Mini cutter coupe-film

**ES:** Minicortador de láminas de plástico

**DE:** Mini-Folienschneider

These disposable, detectable mini plastic sheet cutters have an enclosed blade and a point to puncture packaging.

### Features & Options

5  
PACK

Colour:



**PRODUCT CODE:** 615-K121-T184-P01



## Disposable, Light Duty Metal Detectable Safety Knives with Enclosed Blade

**FR:** Cutter pour emballage

**ES:** Cortador de envoltorios

**DE:** Schneidwerkzeug

These lightweight disposable, detectable safety knives have an enclosed blade and a pointed nose to puncture packaging.



### Features & Options

5  
PACK



**Colours:**



### Features & Options

- Metal detectable
- Enclosed stainless steel blade
- One-piece
- Suitable for ambidextrous use
- Suitable for laser engraving

**PRODUCT CODE:** 615-K106-T030-P0

More product codes available – please contact us for a full price list

## Disposable, Light Duty Metal Detectable Ring Safety Knives

**FR:** Anneau pour couteau de sécurité

**ES:** Anillo con navaja de seguridad

**DE:** Sicherheitsmesserring

These disposable, detectable ring safety knives can be worn at all times, allowing the wearer to keep both hands free and are suitable for cutting plastic wrapping.

5  
PACK



**Colour:**

### Features & Options

- Metal detectable
- Enclosed stainless steel blade
- One-piece
- Suitable for ambidextrous use
- Suitable for laser engraving



**PRODUCT CODE:** 615-K123-T184-P01

## Normal Duty Metal Detectable Safety Knife

FR: Couteau de sécurité à lame rétractable  
 ES: Navaja de seguridad con hoja retráctil  
 DE: Sicherheitsmesser mit einziehbarer Klinge

This detectable safety knife has blade lock control for when a cut is being made, it **automatically retracts with sudden movements** and is suitable for all packaging use.

### Features & Options

1  
PACK

Made In:  
UK 

Colour: 



PRODUCT CODE: 615R-K119-T037-A117

Sequential numbering available for all products

## Normal Duty Metal Detectable Safety Knife with Enclosed Blade and Tape Cutter

FR: Couteau de sécurité avec lame fermée et coupe-bande  
 ES: Cuchillo de seguridad con hoja oculta y cortador de cinta  
 DE: Sicherheitsmesser mit abgedeckter Klinge und Bandabschneider

This detectable safety knife has an enclosed blade plus tape cutter, replaceable blades with four cutting edges and is suitable for all packaging.

### Features & Options

1  
PACK

Colour: 



PRODUCT CODE: 615-K126-T184-P01



**AUTOMATIC  
BLADE  
RETRACTION**

**SUITABLE FOR  
AMBIDEXTROUS  
USE**

**SECURITY KEY  
FOR CONTROLLED  
BLADE CHANGE**

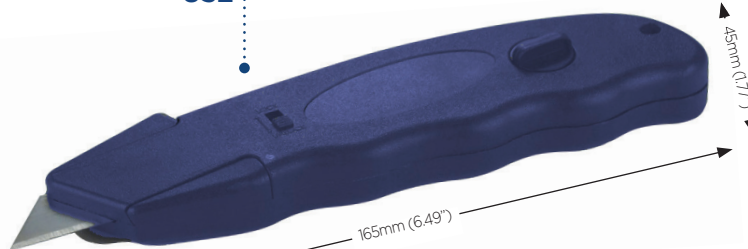

**STAINLESS  
STEEL BLADE**

**SUITABLE  
FOR LASER  
ENGRAVING**

**REPLACEMENT BLADES  
AVAILABLE WITH TWO  
CUTTING EDGES**

In Partnership  
with  
**BROGS**

169

**TAPE CUTTER**

**LANYARD  
POINT**

**SUITABLE FOR  
AMBIDEXTROUS  
USE**



**REPLACEMENT BLADES  
AVAILABLE WITH FOUR  
CUTTING EDGES**

**ENCLOSED  
STAINLESS  
STEEL BLADE**

**SUITABLE  
FOR LASER  
ENGRAVING**

**detectamet**



## Normal Duty Metal Detectable Safety Knives

FR: Couteau de sécurité économique à lame rétractable

ES: Navaja de seguridad económica con hoja retráctil

DE: Preisgünstiges Sicherheitsmesser mit einziehbarer Klinge

These detectable safety knives are ideal for general packaging use, including 2-ply cardboard.

### Features & Options

5  
PACK

STAINLESS STEEL BODY WITH BLUE DETECTABLE PLASTIC PARTS

Colour:

STAINLESS STEEL DOUBLE EDGED BLADE

SEMI-AUTOMATIC BLADE RETRACTION

SUITABLE FOR LASER ENGRAVING

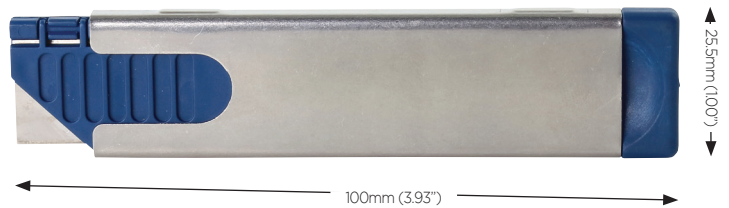
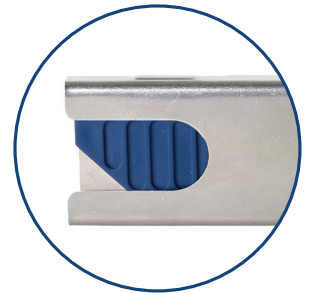

REPLACEMENT BLADES AVAILABLE WITH FOUR CUTTING EDGES

SUITABLE FOR AMBIDEXTROUS USE



PRODUCT CODE: 615-K124-T184-P01

More product codes available – please contact us for a full price list

## Normal Duty Metal Detectable Safety Knives with Dual Enclosed Blades and Tape Cutter

FR: Couteau double lame

ES: Navaja de hoja doble en forma de cangrejo

DE: Krebsmesser mit Doppelklinge

These compact detectable safety knives have a blunt tape cutter and twin blades for push/pull cutting techniques.

### Features & Options

5  
PACK

- Metal detectable
- Enclosed stainless steel blades
- Blunt tape cutter
- One-piece
- Lanyard point
- Suitable for ambidextrous use
- Suitable for laser engraving

Colour:

Made In:  
UK



SUITABLE FOR LASER ENGRAVING

SUITABLE FOR AMBIDEXTROUS USE



PRODUCT CODE: 615-K115-T132-P01

## Normal Duty Metal Detectable & X-Ray Visible Stainless Steel Safety Knife with Auto Retracting Blade

FR: Couteau de sécurité rétractable en acier inoxydable  
 ES: Navaja de seguridad retráctil de acero inoxidable  
 DE: Sicherheitsmesser mit einziehbarer Klinge aus Edelstahl

This fully detectable, retractable safety knife is manufactured from stainless steel.

### Features & Options

1  
PACK

- Metal detectable
- X-Ray visible
- Automatic blade retraction
- NSF certifiable
- Replacement blades available
- Suitable for ambidextrous use
- Suitable for laser engraving



SUITABLE FOR LASER ENGRAVING

SUITABLE FOR AMBIDEXTROUS USE

Colour:



PRODUCT CODE: 615-K125-T513-P45

Sequential numbering available for all products

## Heavy Duty Metal Detectable Aluminium Safety Knife

FR: Couteau de sécurité robuste  
 ES: Navaja de seguridad de alta resistencia  
 DE: Extrastarkes Sicherheitsmesser

This detectable aluminium safety knife is heavy duty and ideal for cutting packaging, including thicker cardboard. Blue plastic on knife is also detectable.

### Features & Options

1  
PACK

Colour:

New Product!

ALSO AVAILABLE WITH A LONGER BLADE LENGTH.



PLEASE NOTE THAT THIS IS A SEPARATE PRODUCT TO OUR STANDARD BLADE HEAVY DUTY ALUMINIUM SAFETY KNIFE.

STAINLESS STEEL DOUBLE EDGED BLADE

SUITABLE FOR AMBIDEXTROUS USE

SUITABLE FOR LASER ENGRAVING

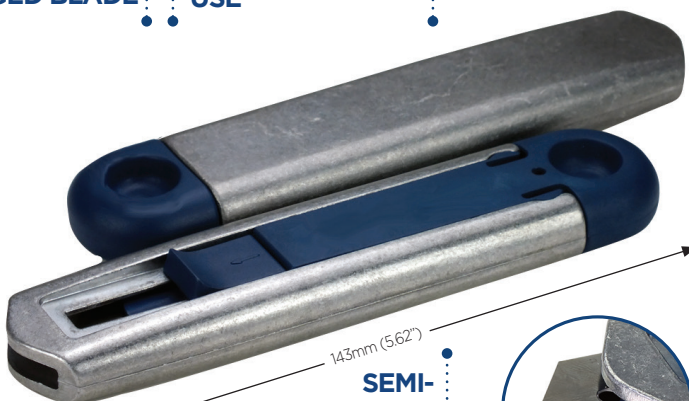

SEMI-AUTOMATIC BLADE RETRACTION

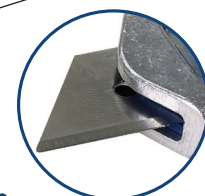

REVERSIBLE REPLACEMENT BLADES AVAILABLE



PRODUCT CODE: 615-K102-T038-P30 & 615-K102E-T038-P30 (Longer Blade)

## Heavy Duty Metal Detectable Safety Knife

FR: Couteau de sécurité robuste

ES: Cuchillo de seguridad de alta resistencia

DE: Extrastarkes Sicherheitsmesser

This heavy duty detectable safety knife has blade lock control for when a cut is being made and **automatically retracts with sudden movements**. Its aluminium blade carrier makes blade changing easier, particularly important for high cardboard use resulting in frequent blade changes.

### Features & Options

1  
PACK

Colour:

Made In:  
UK 



SUITABLE FOR  
AMBIDEXTROUS  
USE

SECURITY KEY  
FOR CONTROLLED  
BLADE CHANGE

STAINLESS  
STEEL BLADE

SUITABLE  
FOR LASER  
ENGRAVING

REPLACEMENT BLADES  
AVAILABLE WITH TWO  
CUTTING EDGES



PRODUCT CODE: 615R-K120-T037-A118

More product codes available – please contact us for a full price list

## Heavy Duty Metal Detectable Safety Knife with Enclosed Blade

FR: Couteau de sécurité robuste

ES: Navaja de seguridad de alta resistencia

DE: Extrastarkes Sicherheitsmesser

This heavy duty detectable safety knife has an enclosed blade, is available with/without a retractable hook, has replaceable reversible blades and is suitable for most packaging.

### Features & Options

1  
PACK

Colour:

Made In:  
UK 



REPLACEMENT  
REVERSIBLE  
BLADES  
AVAILABLE

SUITABLE FOR  
AMBIDEXTROUS  
USE

RETRACTABLE  
HOOK OPTION

OPPOSING SLOPES AT  
MOUTH EXIT REDUCE  
FRICTION FOR A  
MORE EFFICIENT CUT

ENCLOSED  
STAINLESS  
STEEL BLADE

SUITABLE  
FOR LASER  
ENGRAVING



PRODUCT CODE: 615-K118-T197-P01

## Heavy Duty Metal Detectable Safety Knives with Enclosed Blade

FR: Couteau de sécurité à lame crochet

ES: Navaja de seguridad con hoja en gancho

DE: Sicherheitsmesser mit Hakenklinge

These lightweight detectable safety knives have an enclosed blade, hook and tape cutter options, replaceable reversible blades and are suitable for most packaging.

### Features & Options

5  
PACK

Colour:



STANDARD  
(T192)



BLADE  
(T193)



PRODUCT CODE: 615-K109-T195-P01

Sequential numbering available for all products

Made In:  
UK

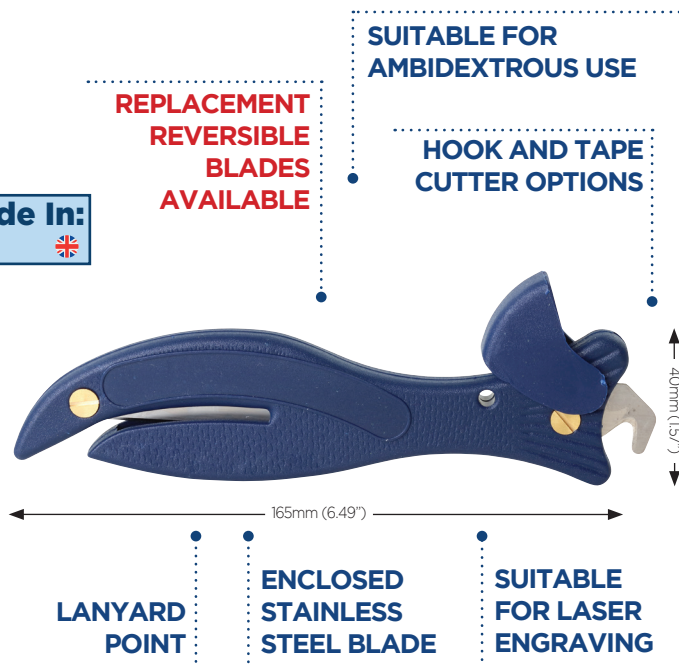

## Heavy Duty Metal Detectable Box Cutter

FR: Cutter à lame Vari-guard rétractable

ES: Cortador de cajas con vari-guard retráctil

DE: Teppichmesser mit einziehbarem Vari-Schutz

This heavy duty detectable box cutter has spring loaded retractable guards and reversible replacement blades. It is perfect for cutting boxes without damaging contents and most plastic packaging.

### Features & Options

- Metal detectable
- Enclosed stainless steel blade
- Security key for safe blade change
- Lanyard point
- Replacement blades available for cutting and hook blade
- Suitable for ambidextrous use
- Suitable for laser engraving

Colour:



1  
PACK

Made In:  
UK



SUITABLE FOR AMBIDEXTROUS USE

PRODUCT CODE: 615-K112-T034-P27



Metal detectable and X-Ray visible **locking knives** are ideal for general purpose use

In Partnership with  
**BRGS**



↑ **DETECTABLE HANDLES** ↑

## Metal Detectable & X-Ray Visible Locking Knife with Lambfoot Blade

FR: Couteau verrouillable avec lame lambfoot (pied d'agneau)

ES: Navaja con hoja de espalda recta

DE: Feststellbares messer mit gerader Klinge (lambfoot)



This heavy duty locking knife comes with a blue detectable handle and has a stainless steel lambsfoot blade, making it ideal for general purpose use.

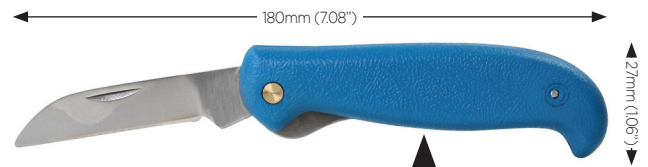

### Features & Options

- Metal detectable
- X-Ray visible
- High carbon stainless steel lockable blade
- Blade has flat cutting edge and a back that curves to the point

### DETECTABLE

- Also available with a shackle (additional cost applicable)
- Blade length: 55mm
- Suitable for pad printing/laser engraving
- This is not a safety knife

Colour:



**PRODUCT CODE:** 605-T042-P01

174

Sequential numbering available for all products • Ask us for a pen and knife guide

## Metal Detectable & X-Ray Visible Locking Knife with Sheepfoot Blade

FR: Couteau verrouillable avec lame sheepfoot (pied de mouton)

ES: Navaja con hoja de punta caída

DE: Feststellbares messer mit gerader Klinge (sheepfoot)



This heavy duty locking knife comes with a blue detectable handle and has a stainless steel sheepfoot blade, making it ideal for general purpose use.

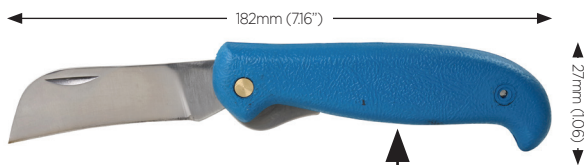

### Features & Options

- Metal detectable
- X-Ray visible
- High carbon stainless steel lockable blade
- Blade has straight edge and straight back that curves towards the edge at the end, giving excellent control
- Also available with a shackle (additional cost applicable)
- Blade length: 55mm
- Suitable for pad printing/laser engraving
- This is not a safety knife

### DETECTABLE

Colour:



**PRODUCT CODE:** 605-T043-P01

## Metal Detectable & X-Ray Visible Locking Knife with Clip Point Blade

FR: Couteau verrouillable avec lame clip point

ES: Navaja con hoja punta de clip

DE: Feststellbares messer mit clip-point-klinge



This heavy duty locking knife comes with a blue detectable handle and has a stainless steel clip point blade, making it ideal for general purpose use.



### Features & Options

- Metal detectable
- X-Ray visible
- High carbon stainless steel lockable blade
- Pointed blade is useful for piercing materials

### DETECTABLE

- Also available with a shackle (additional cost applicable)
- Blade length: 70mm
- Suitable for pad printing/laser engraving
- This is not a safety knife

Colour:



**PRODUCT CODE:** 605-T044-P01

etectamet

## Metal Detectable & X-Ray Visible Locking Knife with Pruning Blade

**FR:** Couteau verrouillable avec lame a élaguer  
**ES:** Navaja de hoja serrada  
**DE:** Feststellbares Gärtnermesser



This heavy duty locking knife comes with a blue detectable handle and has a stainless steel pruning blade, making it ideal for gardening, farming and general purpose use.



### Features & Options

- Metal detectable
- X-Ray visible
- High carbon stainless steel locking blade
- Curved blade, sharpened on concave edge

### DETECTABLE

- Also available with a shackle (additional cost applicable)
- Blade length: 60mm
- Suitable for pad printing/laser engraving
- This is not a safety knife

Colour:

Made In: **UK**

**PRODUCT CODE:** 605-T045-P01

## Metal Detectable & X-Ray Visible Stainless Steel Locking Knife with All Purpose Blade

**FR:** Couteau verrouillable en acier inoxydable avec lame tous usages  
**ES:** Navaja de acero inoxidable multiusos  
**DE:** Feststellbares Edelmessmesser Mit Allzweckklinge



This locking knife has a carbon stainless steel general purpose blade and satin finish stainless steel handle, making it ideal for farming and general purpose use.



### Features & Options

- Metal detectable
- X-Ray visible
- High carbon stainless steel locking blade
- All purpose blade suitable for multiple applications

- Also available with a shackle (additional cost applicable)
- Blade length: 70mm
- Suitable for pad printing/laser engraving
- This is not a safety knife

Colour:

Made In: **UK**

**PRODUCT CODE:** 606-Q04-T220

More product codes available – please contact us for a full price list

## Metal Detectable & X-Ray Visible Stainless Steel Locking Knife with Pruning Blade

**FR:** Couteau verrouillable en acier inoxydable avec lame a élaguer

**ES:** Navaja de acero inoxidable con hoja serrada

**DE:** Feststellbares Gärtnermesser aus edelstahl



This locking knife has a carbon stainless steel pruning blade and satin finish stainless steel handle, making it ideal for farming and general purpose use.



### Features & Options

- Metal detectable
- X-Ray visible
- High carbon stainless steel locking blade
- Curved blade, sharpened on concave edge

- Also available with a shackle (additional cost applicable)
- Blade length: 70mm
- Suitable for pad printing/laser engraving
- This is not a safety knife

Colour:

Made In: **UK**

**PRODUCT CODE:** 606-Q05-T223

## Metal Detectable & X-Ray Visible Stainless Steel Locking Knife with Drop Point Blade

**FR:** Couteau verrouillable en acier inoxydable avec lame drop point

**ES:** Navaja de acero inoxidable con hoja en punta

**DE:** Feststellbares edelmessmesser mit drop-point-klinge



This locking knife has a polished carbon stainless steel drop point blade and satin finish stainless steel handle, making it ideal for general purpose use.



### Features & Options

- Metal detectable
- X-Ray visible
- High carbon stainless steel locking blade
- Blade spine slopes from handle to tip

- Also available with a shackle (additional cost applicable)
- Blade length: 60mm
- Suitable for pad printing/laser engraving
- This is not a safety knife

Colour:

Made In: **UK**

**PRODUCT CODE:** 606-Q06-T226

# Metal Detectable & X-Ray Visible Professional Knives



**FR:** Couteaux professionnels

**ES:** Cuchillos profesionales

**DE:** Messer für den Beruf

176

Vegetable Knives	178
Chef's Knives	178
Boning Knives	179
Turning Knives	179
Paring Knives	180
Broad Flex Filleting Knives	180
Butcher's Knives	181
Dough Knives	181
Wavy Edge Slicers	182
Pallet Knives	182
Bread/Pastry Knives	182
Chopping Board	182
Security Cage	183

# PROFESSIONAL KNIVES

Our detectable professional knives are made from fully hardened and tempered stainless steel to ensure maximum edge retention.

The handles are manufactured from EU & FDA food contact approved detectable polymer.

To achieve maximum hygiene levels, handles are insert moulded to the blades, preventing build-up of contaminants and allowing it to withstand rigorous sterilising and dishwasher use.



## Handles

Depending on knife function and frequency of use, handles come in two different shapes:

**Regular** – designed for holding the knife safely and comfortably for long periods



**Ergo** – designed for all day use by reducing stress to the hand and wrist and providing thumb support



## Edges and Blades

We offer three different types of blade, dependent on function:

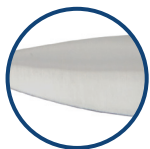

**Plain** – ensures a fine, robust, long lasting edge, predominantly used in the meat processing industry

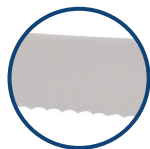

**Serrated/wavy** – the teeth along the blade edge allows a tough cut, whilst protecting the softer inner of a product. This is the perfect edge for cutting bread and pastry

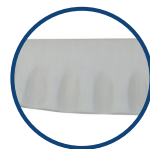

**Scalloped** – with scallops running on each side of the blade, air can enter between the blade and cut products, allowing the cut slice to easily fall away making it perfect for slicing meat

## Colour Coding System

It is crucial to minimise the spread of contamination when dealing with certain allergens that could present a serious threat to health or life. To minimise this risk our knife handles are available in nine detectable colours.





## Metal Detectable & X-Ray Visible Vegetable Knives

FR: Couteau à légumes  
 ES: Cuchillo para verduras  
 DE: Gemüseputzmesser

Made In:  
 UK 

These vegetable knives come in three different blade lengths, have various blade and tip options and are available in nine different colours.

### Features & Options

10  
 PACK

**Best Seller!**

Colours: 

PRODUCT CODE: 600-T20 (straight blade)

Sequential numbering available for all products • Ask us for a pen and knife guide

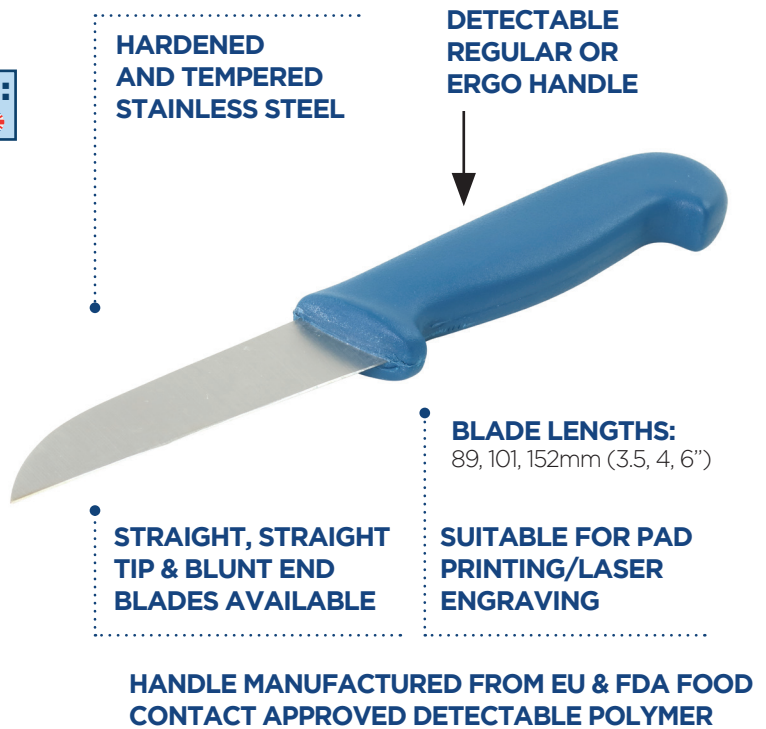

## Metal Detectable & X-Ray Visible Chef's Knives

FR: Couteaux de chef  
 ES: Cuchillos de chef  
 DE: Kochmesser

Made In:  
 UK 

Chef's knives are one of the most commonly used knives in the commercial kitchen and we offer a wide range of blade sizes, each available in nine different colours.

### Features & Options

10  
 PACK

Colours: 

PRODUCT CODE: 600-T047

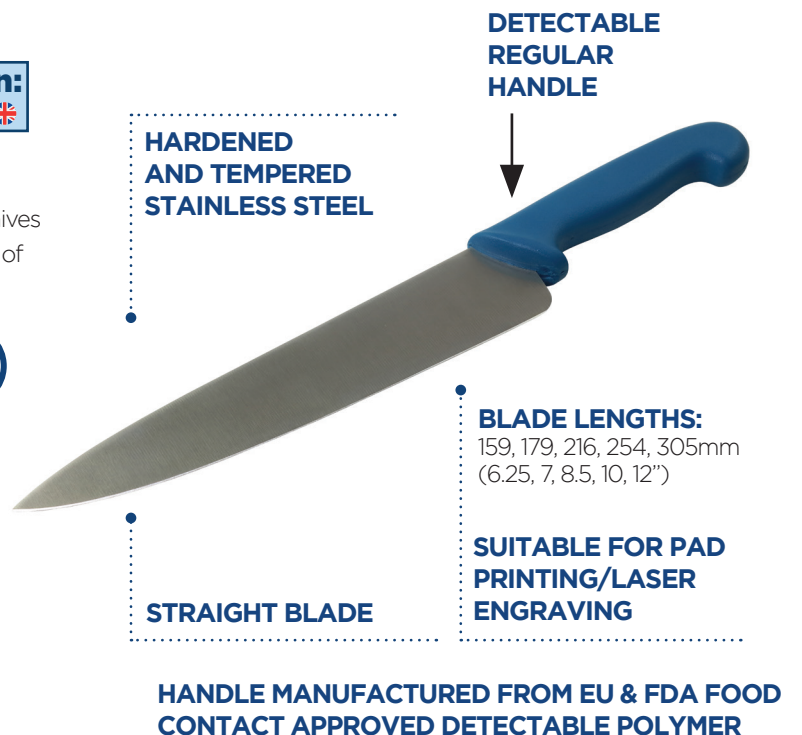

## Metal Detectable & X-Ray Visible Boning Knives

FR: Couteau à désosser

ES: Cuchillo para deshuesar

DE: Ausbeinmesser

Made In:  
UK 

These detectable boning knives come in two blade lengths and types, all available in nine different colours.

DETECTABLE  
REGULAR  
HANDLE

HARDENED  
AND TEMPERED  
STAINLESS  
STEEL

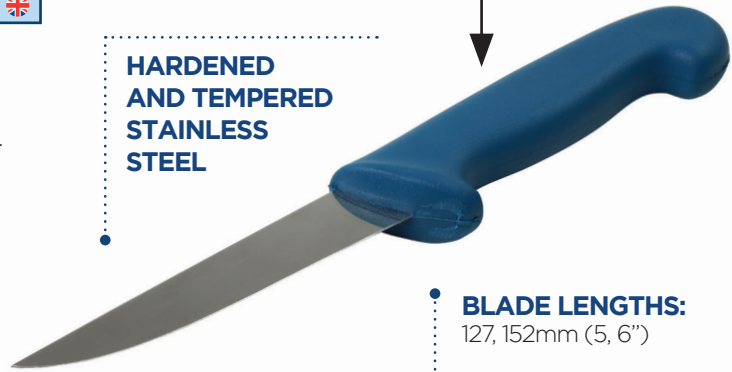

BLADE LENGTHS:  
127, 152mm (5, 6")

SUITABLE FOR PAD  
PRINTING/LASER  
ENGRAVING

### Features & Options

10  
PACK

HANDLE MANUFACTURED FROM EU & FDA FOOD CONTACT APPROVED DETECTABLE POLYMER

STRAIGHT AND  
CURVED BLADES  
AVAILABLE

Colours: 

PRODUCT CODE: 600-T052 (straight blade)

More product codes available – please contact us for a full price list

## Metal Detectable & X-Ray Visible Turning Knives

FR: Couteaux à éplucher

ES: Cuchillos peladores

DE: Tourniermesser

Made In:  
UK 

These detectable turning/peeling knives have a 57mm (2.25") curved blade and are available in nine different colours.

DETECTABLE  
ERGO HANDLE

HARDENED  
AND TEMPERED  
STAINLESS  
STEEL

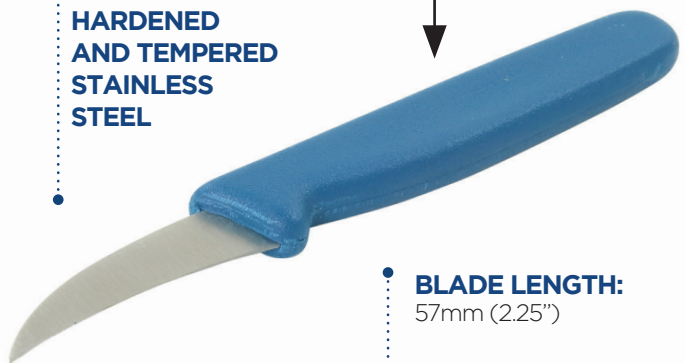

BLADE LENGTH:  
57mm (2.25")

SUITABLE FOR PAD  
PRINTING/LASER  
ENGRAVING

### Features & Options

10  
PACK

CURVED BLADE

HANDLE MANUFACTURED FROM EU & FDA FOOD CONTACT APPROVED DETECTABLE POLYMER

Colours: 

PRODUCT CODE: 600-T085

## Metal Detectable & X-Ray Visible Paring Knives

FR: Couteaux d'office  
 ES: Cuchillos para verduras  
 DE: Schälmesser

Made In:  
 UK 

These detectable paring knives come in two blade and handle lengths and are available in nine different colours.

**Best Seller!**

DETECTABLE ERGO HANDLE

HARDENED AND TEMPERED STAINLESS STEEL

BLADE LENGTHS:  
 76, 102mm (3, 4")

STRAIGHT BLADE

SUITABLE FOR PAD PRINTING/LASER ENGRAVING

HANDLE MANUFACTURED FROM EU & FDA FOOD CONTACT APPROVED DETECTABLE POLYMER

### Features & Options

10  
 PACK

Colours: 

PRODUCT CODE: 600-T056

Sequential numbering available for all products • Ask us for a pen and knife guide

## Metal Detectable & X-Ray Visible Broad Flex Filleting Knives

FR: Couteaux à fileter larges flexibles  
 ES: Cuchillos de fileteado flexibles y anchos  
 DE: Filetmesser mit breiter Klinge

Made In:  
 UK 

These detectable broad flex filleting knives come in two blade lengths and are available in nine different colours.

DETECTABLE REGULAR HANDLE

HARDENED AND TEMPERED STAINLESS STEEL

BLADE LENGTHS:  
 152, 165mm (6, 6.5")

STRAIGHT BLADE

SUITABLE FOR PAD PRINTING/LASER ENGRAVING

HANDLE MANUFACTURED FROM EU & FDA FOOD CONTACT APPROVED DETECTABLE POLYMER

### Features & Options

10  
 PACK

Colours: 

PRODUCT CODE: 600-T053

## Metal Detectable & X-Ray Visible Butcher's Knives

FR: Couteau de boucher

ES: Cuchillo de carnicero

DE: Metzgermesser

These detectable butcher's knives come in two different blade lengths, both available in nine different colours.

Made In:  
UK 

10  
PACK

### Features & Options

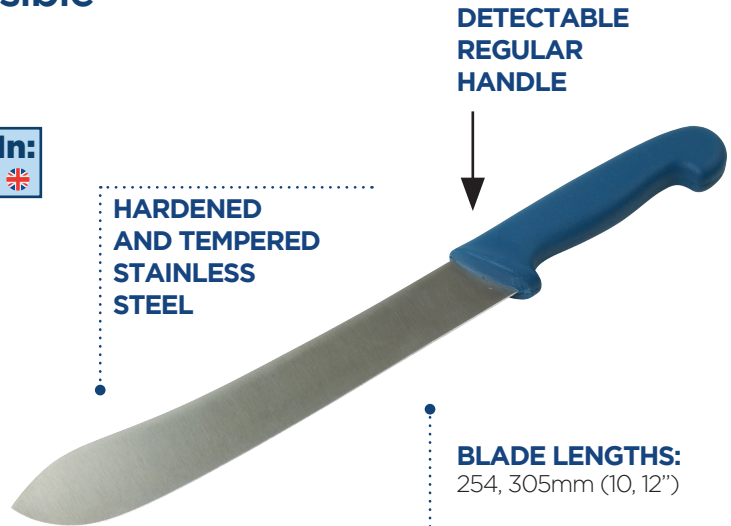

HARDENED  
AND TEMPERED  
STAINLESS  
STEEL

DETECTABLE  
REGULAR  
HANDLE

STRAIGHT BLADE

BLADE LENGTHS:  
254, 305mm (10, 12")

SUITABLE FOR PAD  
PRINTING/LASER  
ENGRAVING

HANDLE MANUFACTURED FROM EU & FDA FOOD  
CONTACT APPROVED DETECTABLE POLYMER

Colours: 

PRODUCT CODE: 600-T048

More product codes available – please contact us for a full price list

In Partnership  
with  
**BREGS**

181

## Metal Detectable & X-Ray Visible Dough Knives

FR: Couteaux à pâte

ES: Cuchillos para masa

DE: Teigmesser

These detectable dough knives have a 203mm (8") curved blade and are available in nine different colours.

Made In:  
UK 

10  
PACK

### Features & Options

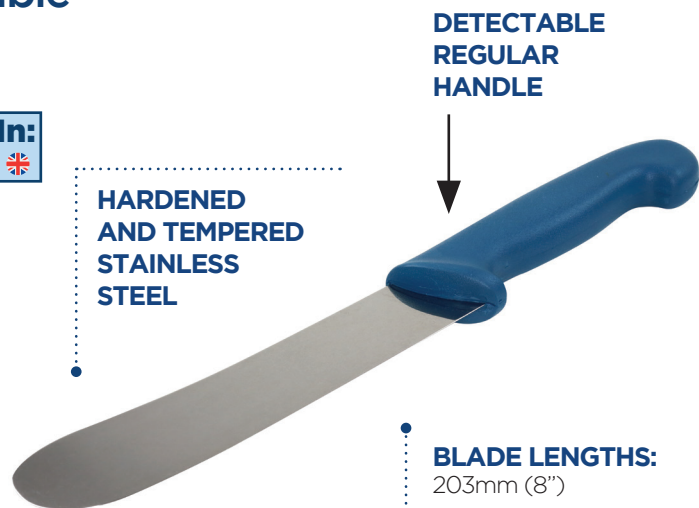

HARDENED  
AND TEMPERED  
STAINLESS  
STEEL

DETECTABLE  
REGULAR  
HANDLE

STRAIGHT BLADE

BLADE LENGTHS:  
203mm (8")

SUITABLE FOR PAD  
PRINTING/LASER  
ENGRAVING

HANDLE MANUFACTURED FROM EU & FDA FOOD  
CONTACT APPROVED DETECTABLE POLYMER

Colours: 

PRODUCT CODE: 600-T084

**detectamet**



# Metal Detectable & X-Ray Visible Professional Knives

## Metal Detectable & X-Ray Visible Wavy Edge Slicers

FR: Couteau à pain  
 ES: Cuchillo con borde ondulado  
 DE: Brotmesser

10  
PACK

These detectable wavy edge slicers come in two blade lengths, both available in nine different colours.

Made In:  
UK



### Features & Options

- Metal detectable
- X-Ray visible
- Handle manufactured from EU & FDA food contact approved detectable polymer
- Hardened and tempered stainless steel
- Serrated blade
- Regular handle
- Blade lengths: 254, 305mm (10, 12")
- Suitable for pad printing/laser engraving

Colours:

PRODUCT CODE: 600-T046

## Metal Detectable & X-Ray Visible Palette Knives

FR: Couteau à palette  
 ES: Cuchillo de paleta  
 DE: Palettenmesser

Made In:  
UK

10  
PACK

These detectable palette knives come in four blade lengths, all available in nine different colours.



### Features & Options

- Metal detectable
- X-Ray visible
- Handle manufactured from EU & FDA food contact approved detectable polymer
- Hardened and tempered stainless steel
- Straight blade
- Regular handle
- Blade lengths: 152, 203, 254, 305mm (6, 8, 10, 12")
- Suitable for pad printing/laser engraving

Colours:

PRODUCT CODE: 600-T051

Sequential numbering available for all products • Ask us for a pen and knife guide

## Metal Detectable & X-Ray Visible Bread/Pastry Knives

FR: Couteau à pain  
 ES: Cuchillo con borde ondulado  
 DE: Brotmesser

10  
PACK

These detectable bread/pastry knives have a 254mm (10") blade, and are available in nine different colours.

Made In:  
UK



### Features & Options

- Metal detectable
- X-Ray visible
- Handle manufactured from EU & FDA food contact approved detectable polymer
- Hardened and tempered stainless steel
- Serrated blade
- Regular handle
- Blade size: 254mm (10")
- Suitable for pad printing/laser engraving

Colours:

PRODUCT CODE: 600-T055

## Metal Detectable Cutting/Chopping Board

FR: Planche à découper et à hacher  
 ES: Tabla de cortar/picar  
 DE: Schneidebrett

1  
PACK

This metal detectable chopping board is available in two sizes and has been approved for contact with food.

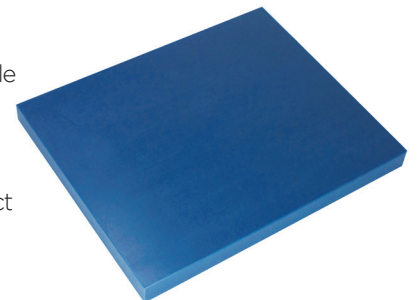

### Features & Options

- Metal detectable
- Excellent wear/abrasion resistance
- FDA and EU Directive 2002/72 EC compliant
- Suitable for low temperature environments -260°C (-436°F) up to 80 °C (176 °F)
- Sizes: 610 x 457 x 10mm (24.01 x 17.99 x 0.39") 610 x 457 x 50mm (24.01 x 17.99 x 1.96") (other sizes available on request)

Made In:  
UK  
USA

Colours:

PRODUCT CODES: 826-S375-P01 (610 x 457 x 10mm) 826-S376-P01 (610 x 457 x 50mm)

# Security Cage

FR: Cages de sécurité

ES: Jaulas de seguridad

DE: Kasten mit Sicherheitsgitter

Keep tools safe and secure with this lockable security cage, contributing to internal traceability systems.

Bespoke  
Sizes  
Available

1  
PACK

## Features & Options

Made In:  
UK 

REDUCES RISK OF CROSS  
CONTAMINATION

COMPLETELY  
CUSTOMISABLE

SUPPLIED WITH  
STAINLESS STEEL  
FITTINGS / PURPOSE  
BUILT HOLDERS FOR  
HANGING & SECURING  
TOOLS

LOCKABLE

### Features & Options

- Size shown:  
350 x 75 x 500 mm  
(13.77 x 2.95 x 19.68")
- Bespoke sizes available
- Site visits available



Colours: 

PRODUCT CODE: 620-P45

In Partnership  
with  
**BROGS**

183

**detectamet**

# Metal Detectable & X-Ray Visible Engineering Products & Test Pieces

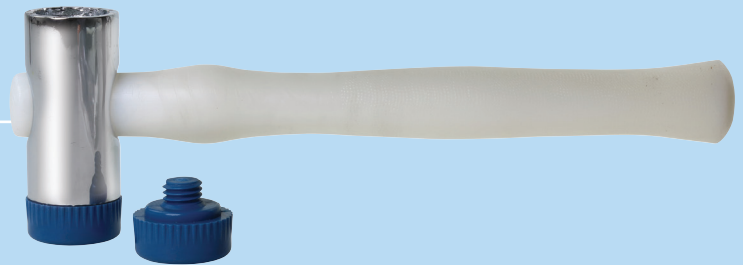

FR: Ingénierie

ES: Ingeniería

DE: Technik

184

Mallet	185
Mallet with Screw-in Faces	186
Test Pieces	187
Detectasil	191
UHMWPE	192
O-Ring	193
Acetal	193
Silicone Rubber Sheetting, Strips and Extrusions	194
PTFE	194
Polyurethane Belting	195
PA6 Filled Nylon	195
PEEK	196
Mat	196
Floor Signs & Floor Sticker Signs	197

# Partially Metal Detectable & X-Ray Visible Mallet

FR: Maillet

ES: Maza

DE: Fäustel

This detectable mallet is available in three sizes. The head is manufactured from durable detectable plastic making it capable of providing high impact whilst minimising the risk of contamination.

## Features & Options



(head only)



(head only)



**FIBREGLASS HANDLE**  
(small size has additional rubber grip)

**POLYPROPYLENE HANDLE**  
(non-detectable)

**POLYPROPYLENE HANDLE**  
(non-detectable)

**SIZES:**

small - head dia. 25 mm (0.98")  
length 255 mm (10.03")  
height 76 mm (2.99")  
weight 156 g (5 1/2oz)

medium - head dia. 50 mm (1.96")  
length 300 mm (11.81")  
height 118 mm (4.64")  
weight 381 g (13 1/2oz)

large - head dia. 80 mm (3.14")  
length 320 mm (12.59")  
height 127 mm (5.00")  
weight 770 g (27oz)

**COLOUR:** ■ (head)

**PRODUCT CODE:** 810-S056-P01 (25mm dia.),  
810-S062-P01 (50mm dia.), 810-S080-P01 (80mm dia.)



# Partially Metal Detectable & X-Ray Visible Mallet with Screw-in Faces

FR: Marteau à capuchons remplaçables vissables

ES: Martillo con cabezales de repuesto a rosca

DE: Hammer mit Ersatz-Schraubkappen



A heavy duty mallet with screw-in detectable replacement caps. This is an ideal multi-purposed striking tool.

## Features & Options



(head only)



(head only)

### OVERALL WEIGHT:

650g (23oz)

### POLYPROPYLENE HANDLE

### RESILIENT

300mm (11.81")

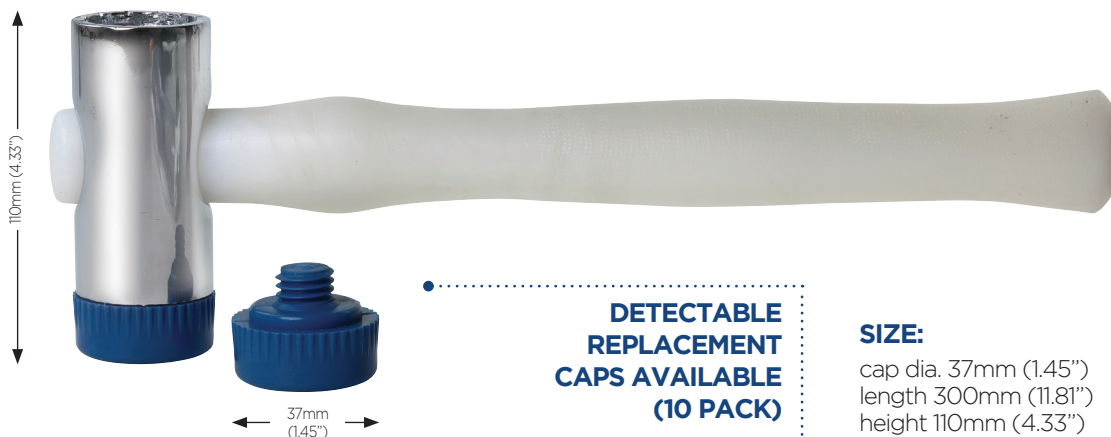

**DETECTABLE REPLACEMENT CAPS AVAILABLE (10 PACK)**

### SIZE:

cap dia. 37mm (1.45")  
length 300mm (11.81")  
height 110mm (4.33")

COLOURS:  (head)

**PRODUCT CODE:** 810-S693-P01 (mallet), 810-S694-P01 (replacement caps)

# Metal & X-Ray Calibration Test Pieces

FR: Pièces de test d'étalonnage compatibles avec les systèmes d'inspection par rayons X ou de détection des métaux

ES: Objetos para pruebas de calibración de rayos X y detección de metales

DE: Metall- und Röntgenkalibrierungs-Prüfkörper



## Features & Options

- HACCP compliance requires inspection equipment to be installed at critical control points and be routinely QA tested with the results documented. Using these test pieces allows you to demonstrate your commitment to a QMS
- Manufactured from Acrylic, heavy duty PTFE or FDA Acetal Copolymer
- Available in a variety of sizes and types of contaminants
- Calibrated and certified to BS EN ISO 9002 and UKAS - offering full traceability
- Manufactured with high visibility colours for easy recognition and etched with a traceable code
- Each test piece comes with a FREE certificate of conformity
- Bespoke Test Pieces are available upon request - please contact your local sales representative for more details



**FREE CERTIFICATE OF CONFORMITY WITH ALL TEST PIECES**

We can also supply bespoke test kits containing your most used test pieces. Storage boxes are also available to keep your range of calibration pieces safe. All bespoke test kits are supplied with a USB stick with relevant Certificate of Conformity information.



In Partnership with  
**BRCGS**

187

**Detectamet**

# Test Piece Contaminants

- Ferrous - Chrome
- Non-Ferrous - Brass
- Stainless Steel 316
- Stainless Steel Wire 316
- Stainless Steel 304
- Stainless Steel 420
- Stainless Steel 440C
- Titanium
- Phosphor Bronze
- Copper Wire
- Aluminium
- Ceramic
- Glass - Soda Lime
- Glass - Borosilicate (black)
- Glass - Crystal
- PTFE Teflon
- Nylon Grade 1
- Rubber Nitrile
- Zircona

**Bespoke Test Pieces are available upon request. Please contact your local sales representative for more details.**

In Partnership with  
**BRCGS**

188

**FREE CERTIFICATE OF CONFORMITY WITH ALL TEST PIECES**



## Laminated X-Ray Test Card

FR: Carte de test aux rayons X plastifiée  
ES: Tarjeta de prueba radiográfica laminada  
DE: Laminierte Röntgenprüfkarte



PERFECT FOR SLIDING BETWEEN PACKAGING & FOOD ITEMS

WIPE-CLEAN SURFACE

ONLY 1 MM THICK

**Size:**  
Standard: 84 x 60 x 1 mm (3.30 x 60 x 0.04")

Bespoke Sizes Available

**Colours:**

Acrylic:



**Detectamet**

# Metal Detectable & X-Ray Visible Test Pieces

## Test Stick

FR: Baguettes/tiges/bâtons de test  
 ES: Varillas/bastones/barras de prueba  
 DE: Teststäbe/Prüfstäbe/Teststäbchen



Available with Same Day Despatch!

### Sizes:

100 x 12 x 10mm (3.93 x 0.47 x 0.39")  
 100 x 20 x 20mm (3.93 x 0.78 x 0.78")  
 100 x 30 x 30mm (3.93 x 1.18 x 1.18")

Bespoke Stick Sizes Available

### Colours:

Acetal

PTFE

Acrylic



PRODUCT CODE: STICK

## X-Ray Test Card

FR: Cartes test pour rayons X  
 ES: Tarjeta de ensayo de rayos X  
 DE: Röntgen-Testkarte

4.0 mm Soda Lime Glass  
 Cert No: 239696ZA  
[www.detectamet.com](http://www.detectamet.com)

### Colour:

PVC Foam

### Size:

Standard: 80 x 40 x 10mm (3.14 x 1.57 x 0.39")

Bespoke Sizes Available



PRODUCT CODE: X-RAY CARD

FREE CERTIFICATE OF CONFORMITY WITH ALL TEST PIECES



## Test Ball

FR: Billes de test  
 ES: Bolas de prueba  
 DE: Testkugeln



### Sizes (diameter):

50mm (1.96")  
 35mm (1.37")  
 30mm (1.18")

### Colours:

Acrylic:



PRODUCT CODE: BALL

## Test Card

FR: Cartes de test  
 ES: Tarjetas de prueba  
 DE: Testkarten

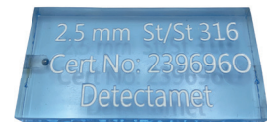

### Sizes:

80 x 40 x 10mm (3.14 x 1.57 x 0.39")

Bespoke Sizes Available

### Colours:

Acetal

PTFE

Acrylic



PRODUCT CODE: CARD

In Partnership with  
**BROGS**

189

**Detectamet**



# Metal Detectable & X-Ray Visible Test Pieces

## Test Puck

FR: Galets/disques de test  
 ES: Discos de prueba  
 DE: Testpucks/Prüfscheiben



**Sizes (diameter):**  
 35 x 10mm (1.37 x 0.39")

Bespoke Sizes Available

**Colours:**  
 Acetal   
 PTFE   
 Acrylic



**PRODUCT CODE:** PUCK

## Test Cube

FR: Cubes de test  
 ES: Cubos de prueba  
 DE: Test-Würfel



**Sizes:**  
 30mm x 30mm x 30mm (1.18 x 1.18 x 1.18")  
 20mm x 20mm x 20mm (0.78 x 0.78 x 0.78")

Bespoke Sizes Available

**Colours:**  
 Acetal    
 PTFE   
 Acrylic



**PRODUCT CODE:** CUBE

**FREE CERTIFICATE OF CONFORMITY WITH ALL TEST PIECES**



## Flexi Test Stick

FR: Baguettes flexibles de test  
 ES: Barra de ensayo Flexi  
 DE: Flexibler Teststreifen



**Size:**  
 Handle 100 x 20 x 20mm (3.93" x 0.78" x 0.78")  
 Hosing outside dia. 8mm (0.31")  
 Hosing length 500mm (19.68")

Bespoke Sizes Available

**Colours:**  
 Acetal   
 PTFE   
 Acrylic



**PRODUCT CODE:** FLEXI

## T-Bar Test Stick

FR: Bâton de test T-Bar  
 ES: Barra de prueba de barra en T  
 DE: T-Bar Test Stick



**Total Size:**  
 Width 100mm (3.93")  
 Length 150mm (5.90")  
 Thickness 20mm x 10mm (0.78" x 0.39")

Bespoke Sizes Available

**Colours:**  
 Acetal   
 PTFE



**PRODUCT CODE:** T-BAR

# Metal & X-Ray Detectable Detectasil® Silicone Caulk

FR: Joint au silicone Detectasil®

ES: Sellante de silicona Detectasil®

DE: Detectasil® Silikondichtmittel



This innovative product, detectable by both metal detectors and X-Ray detection systems, is perfect for use in structural fitting and equipment installation within food processing areas, reducing your risk of undetected foreign body contamination of food.

Detectasil® is a neutral cure sealant, which offers better adhesive properties for a greater number of materials including PVC-U, most other plastics, glass, aluminium, lead, stone and masonry and Polycarbonate.

## Features & Options



**DETECTABLE BY STANDARD METAL AND X-RAY DETECTION SYSTEMS**

**SERVICE TEMPERATURES OF - 30°C TO + 150°C (-22 TO 302°F)**

**NEUTRAL CURE - BETTER ADHESIVE PROPERTIES**

**TUBE IS 32CM LONG (INCLUDING NOZZLE) AND 5CM DIAMETER**

**NOT SAFE FOR FOOD CONTACT**

**UNPALATABLE TO RODENTS**

**FOR USE WITH A STANDARD APPLICATOR GUN**

**LONG SERVICE LIFE - UNOPENED WILL STORE FOR 12 MONTHS**

**SUITABLE APPLICATIONS:**  
windows & doors, wall panels, machinery, finishing, basins and other sanitaryware



COLOURS:  

**PRODUCT CODE:** 820-P01 (blue), 820-P06 (white)

# Metal Detectable 'Detectathene' UHMWPE

FR: UHMWPE

ES: UHMWPE

DE: UHMWPE

This UHMWPE, with an extremely high degree of polymerisation, contains a metal detectable additive and offers excellent toughness, impact strength, and wear/abrasion resistance. FDA approved, it has been specifically designed for use in the food processing and packaging industries to prevent foreign body contamination.

This is a **bespoke product** so please talk to a sales representative for more details.

## Features & Options

1  
PACK



FDA AND EU  
DIRECTIVE 2002/72  
EC COMPLIANT

LOW FRICTION MATERIAL  
IDEAL FOR FOOD PROCESSING  
& TRANSPORTATION

CONTINUOUS USE  
TEMPERATURE UP TO  
80°C (176°F) AND IDEAL  
FOR USE IN CRYOGENIC  
ENVIRONMENTS



GOOD MACHINING  
QUALITIES ALLOW FOR  
PRODUCTION OF MORE  
INTRICATE, COMPLEX  
PARTS

USES: CHAIN GUIDER  
ELEMENTS, FUNNELS,  
ROLLS, BUSHINGS

NON-STICK SURFACE  
ALLOWS FOR  
EXCEPTIONAL SLIDING  
PROPERTIES

COLOUR: ■

PRODUCT CODE: 823-

## Metal Detectable & X-Ray Visible O-Ring

FR: Joints toriques

ES: Juntas tóricas

DE: O-Ringe

This detectable o-ring has been specifically developed to meet the stringent demands of the food and pharmaceutical industries and is manufactured as a bespoke product. Available in several sizes and colours, the majority of sizes are FDA compliant or are manufactured from food safe grades of EPDM, nitrile and fluorocarbon (FKM) compounds.

Fragments as small as 2mm can be identified by standard metal detection equipment.

MANUFACTURED FROM FDA COMPLIANT ELASTOMERIC MATERIALS

DESIGNED FOR MICROBIAL, HIGH-TEMPERATURE AND MECHANICAL APPLICATIONS

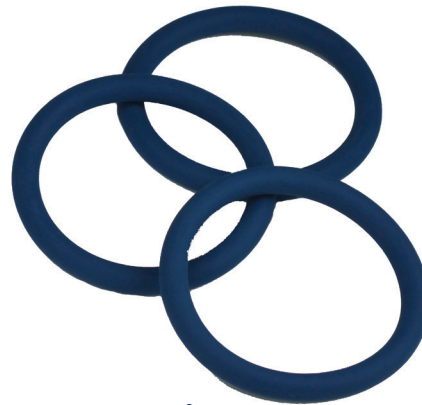

TEMPERATURE RANGE -50 TO 200°C (-58 TO 392°F)

### Features & Options

1  
PACK

Colours:  Other colours available on request

PRODUCT CODE: 970-

More product codes available – please contact us for a full price list

## Metal Detectable & X-Ray Visible Acetal

FR: Acetal

ES: Acetal

DE: Acetal

This copolymer acetal, containing a metal detectable additive, has been specifically designed for use in the food processing and packaging industries, where it can easily be traced by conventional metal detection systems. *Results may vary depending on the sensitivity of the metal detection system used.*

It presents good mechanical strength, stiffness and impact strength and it features a food contact compliant composition.

This is a bespoke product so please talk to a sales representative for more details.

### Features & Options

1  
PACK

FDA AND EU DIRECTIVE 2002/72 EC COMPLIANT

USES: FUNNELS, GEARS, GUIDERS, GRIPERS, SCRAPERS

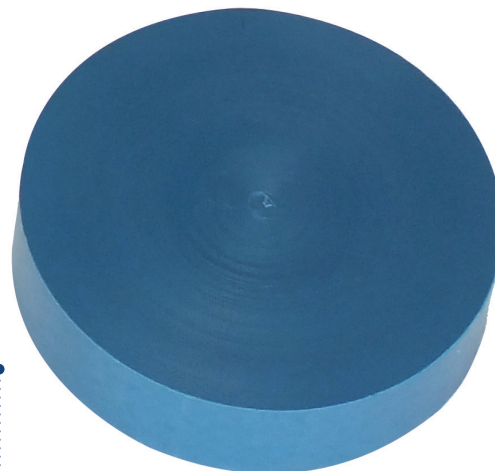

TEMPERATURE RANGE -30 TO 90°C (-22 TO 194°F)

Colour: 

PRODUCT CODE: 830-



## Metal Detectable Silicone Rubber Sheeting, Strips and Extrusions

FR: Feuille en caoutchouc silicone

ES: Lámina de caucho de silicona

DE: Silikongummiunterlage

This metal detectable Silicone is available in rubber sheeting, strips and extrusions, all manufactured from FDA approved food safe materials. It is perfect for demanding applications, having excellent heat and flame resistance and good aging and weathering characteristics.

This is a bespoke product so please talk to a sales representative for more details.

**TEMPERATURE RANGE** -60 TO 200°C (-76 TO 392°F)

**FDA COMPLIANT TO 21 CFR 177.2600**

**SHEETING, STRIPS & EXTRUSIONS**

**SHORE HARDNESS** +/- 5° TO 60°

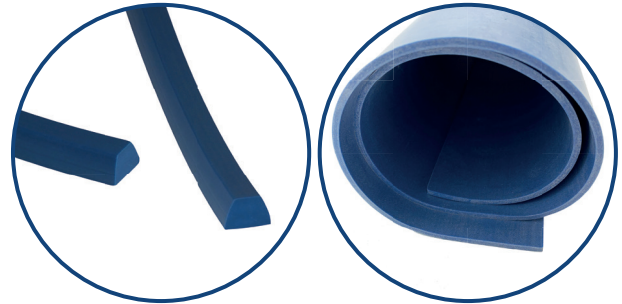

### Features & Options

**1**  
PACK

**Made In:**  
**UK**

**THICKNESS**  
1.5, 2, 3, 4, 6, 10mm  
(0.05, 0.07, 0.11, 0.15, 0.23, 0.39")

Other thicknesses available on request

**EASILY CONVERTED INTO: GASKETS, ELECTRICAL SEALS, WASHERS ETC.**

Colour:

**PRODUCT CODE:** 817-

Sequential numbering available for all products • Ask us for a pen and knife guide

## Metal Detectable & X-Ray Visible PTFE

FR: PTFE

ES: PTFE

DE: PTFE

This is an FDA approved blue PTFE, both metal detectable and X-Ray visible, which ensures that fragments as small as 3 x 3 x 3mm (0.11 x 0.11 x 0.11") can easily be detected, avoiding foreign body contamination.

This is a bespoke product so please talk to a sales representative for more details.

**CONTINUOUS USE TEMPERATURE UP TO 260°C (500°F)**

**HIGH DIMENSIONAL STABILITY**

**AVAILABLE IN MOULDED TUBES, RODS AND SHEETS**

**FDA COMPLIANT TO 21 CFR 177.2600**

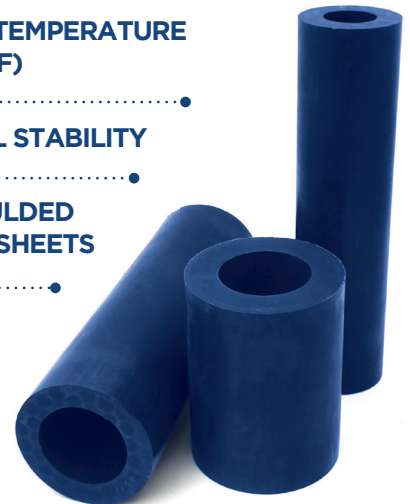

### Features & Options

**1**  
PACK

Colour:

#### MOULDED TUBES

OD: 40 - 1815 mm (1.57 - 71.45")

ID: 15 - 1740 mm (0.59 - 68.50")

Max Length: 300 mm up to 350 mm OD (11.81" up to 13.77" OD)

100 mm up to 1815 mm OD (3.93" up to 71.45" OD)

#### MOULDED RODS

OD: 30 - 700 mm (1.18 - 27.55")

Max Length: 300 mm up to 330 mm OD (11.81" up to 12.99" OD)

100 mm up to 700 mm OD (3.93" up to 27.55" OD)

#### MOULDED SHEETS

600 mm - 1000 x 2000 mm (23.62" - 39.37 x 78.74")

Thickness: 4 - 100 mm (0.15 - 3.93")

**PRODUCT CODE:** 835-

## Metal Detectable & X-Ray Visible 'Detectathane' Polyurethane Belting

FR: Courroies en polyuréthane

ES: Correas de poliuretano

DE: Polyurethan-gurt

This blue polyurethane contains a metal detectable additive. It is FDA and EU approved, specifically designed for use in the food processing and packaging industries where it is traceable by conventional detection systems. *Results may vary depending on the sensitivity of the metal detection system being used.*

It is specifically targeted for extruded profiles, film and sheet applications and it exhibits the excellent abrasion resistance and properties found with standard thermoplastic polyurethanes (TPU) whilst also being metal detectable.

This is a bespoke product so please talk to a sales representative for more details.

Colour: 

PRODUCT CODE: 832-

More product codes available – please contact us for a full price list

### Features & Options

1  
PACK

EXCELLENT ABRASION  
RESISTANCE AND DURABILITY  
AVAILABLE IN FLAT EXTRUSION  
FORMAT

FDA AND EU  
COMPLIANT  
FOR FOOD  
CONTACT

Made In:  
UK 



ALL BELTING CAN BE  
HEAT WELDED FOR  
ENDLESS CONNECTIONS  
- CUT TO ANY SHAPE  
REQUIRED FROM SHEET  
PRODUCT

SUITABLE FOR  
WEAR STRIPS,  
CHUTE LININGS,  
CONVEYOR BELTS  
AND GASKETS

In Partnership  
with

**BREGS**

195

## Metal Detectable & X-Ray Visible PA6 Filled Nylon

FR: Nylon renforcé en PA6

ES: Nylon con poliamida 6

DE: Nylon mit PA6-füllung

This blue polyamide 6 grade contains a metal detectable additive. It is FDA and EU approved, specifically designed for use in the food processing and packaging industries where it is traceable by conventional detection systems.

Detectable Filled Nylon presents good mechanical strength, stiffness, impact strength and wear resistance.

This is a bespoke product so please talk to a sales representative for more details.

### Features & Options

1  
PACK

FDA AND EU  
COMPLIANT  
FOR FOOD  
CONTACT

HIGH WEAR  
AND FATIGUE  
RESISTANCE

LOWER  
MOISTURE  
ABSORPTION  
THAN  
STANDARD  
PA6



AVAILABLE  
IN SHEET,  
BAR STOCK  
& MACHINED  
PARTS

CONTINUOUS USE  
TEMPERATURE UP  
TO 85°C (185°F)

SUITABLE FOR USE IN  
THRUST WASHERS,  
SEALS AND ROLLS

Colour: 

PRODUCT CODE: 823-

**Detectamet**

## Metal Detectable & X-Ray Visible PEEK

FR: PEEK  
ES: PEEK  
DE: PEEK

This dark grey PEEK contains a metal detectable additive. It is FDA and EU approved, specifically designed for use in the food processing and packaging industries where it is traceable by conventional detection systems. *Result may vary depending on the sensitivity of the metal detection system being used.*

It is designed for multiple sterilisable machine parts and continual use up to 250°C (482°F) in applications where good wear resistance is necessary for high line speeds, mainly in equipment with CIP or SIP (cleaning or sterilisation in place) requirements.

This is a bespoke product so please talk to a sales representative for more details.

Colour: 

### Features & Options

1  
PACK

FDA AND EU  
COMPLIANT  
FOR FOOD  
CONTACT

RESISTANT  
TO STEAM

GOOD IMPACT/  
STIFFNESS  
RATIO

HIGH  
DIMENSIONAL  
STABILITY FOR  
HIGH PRECISION  
PARTS



SUITABLE FOR  
FOOD APPROVED  
PARTS REQUIRING  
HIGH STIFFNESS  
WITHOUT  
REINFORCEMENTS

SUITABLE FOR USE IN:

filling pistons, manifolds, valves, scrapers in cookers and high temperature mixers, hot oil applications in fryers and ovens, thrust washers, guiders and bushings

**PRODUCT CODE:** This is a bespoke product so please talk to a sales representative for more details.

Sequential numbering available for all products • Ask us for a pen and knife guide

## Metal Detectable Health & Safety Floor Stickers

FR: Autocollants au sol  
ES: Pegatinas de piso  
DE: Bodenaufkleber

Made In:  
UK 

New  
Product!

Keep your workplace organised and your workforce safe with our metal detectable floor stickers. With strong adhesive to the back of the sticker, these will stick to floors, carpets and walls. Custom sizes are available upon request.



**SIZE:**

254mm (10") Diameter

**PRODUCT CODE:** 405

# Metal & X-Ray Detectable Floor Sign

FR: Signe de plancher

ES: Señal de piso

DE: Bodenschild



Metal detectable & X-ray visible Floor Sign, available in 9 vibrant colours. Alongside our range of standard sign messages, we can also provide customised signage with any sign design and language.

## Features & Options

New Product!

1 PACK

Bespoke signs are also available in stainless steel and anodised aluminium

### Features & Options

- Metal detectable
- X-Ray visible
- This is a bespoke product so please talk to a sales representative for more details.
- Size:  
Face of sign: 600 x 300 mm (23.62 x 11.81")  
Span when open: 520mm (20.47")

1 PACK

Colour:



CUSTOMISABLE SIGNAGE AVAILABLE SUBJECT TO MINIMUM ORDER QUANTITY

FOLDS FLAT FOR CONVENIENT STORAGE



Colours:

**PRODUCT CODE:** 404-PO (Plastic), 464-T130 (Stainless Steel / Aluminium)

In Partnership with

**BROGS**

197

**Detectamet**



Acetal	193	with Enclosed Blade and Tape Cutter	Heavy Duty Detectable Box Cutter	173
All Purpose Blade	175	Disposable Safety Knives	Heavy Duty Detectable Safety Knife	172
Aluminium Flip Chart	61	with Enclosed Blades and Tape Cutter	Heavy Duty Detectable Safety Knives	173
Aluminium or Stainless Steel Clipboard	48	with Hook Blade	with Enclosed Blade	
Badge Reels	39	Disposable Safety Knives	Heavy Duty Detectable Steel	172
Bag Closure Grips	147	with Hook Blade	Safety Knife with Enclosed Blade	
Bag Grippers	147	Disposable Sleeve Covers	Heavy Duty Retractable Pens	16
Balaclava Hoods/Mob/Bouffant Caps	87	Double Sided Tape	Highlighters	26
Beard Snoods	86	Dough Knives	How to use Detectamet's Marker	25
Bench Scraper & Small Scraper	110	Drop Point Blade	Identification and Lockout Tags	157
Boning Knives	179	Dustpan	Ink Types	10
Branding and Sequential Numbering	183	Ear Plug Dispenser	Jaw Clips	53
Bread/Pastry Knives	182	Ear Savers	Jug with Lid	115
Broad Flex Filleting Knives	180	Earplug Box	Jumbo Chrome Plated Clips	51
Brushes & Brooms	131	Easy Grip Pen Sleeve	Keyhole Loop Tags	150
Bucket with Lid	116	Economy Clipboard Clips	Lambfoot Blade	174
Bucket without Handle	117	Elephant One-Piece Pens	Laminated X-Ray Test Card	188
Bulldog / Bag Clips	52	Elephant Retractable Pens	Large Hand Brush	133
Butcher's Knives	181	Envelope Style Document Holder	Large Paddle	127
Cable Clamps	154	Expandaband	Lever Arch File	59
Cable Identification Tags	154	Extra Large Tote Bin Covers	Lightweight Over Glasses	94
Cable Organiser	154	Face Coverings	Lightweight Safety Glasses	94
Cable Tie Mounts	154	Face Mask Dispenser	Litter-Free Wristband	93
Calculator Holder	33	Face Mask Spacer / Bracket	Long Writing Pens	20
Chef's Knives	178	Face Shields	Looped Identification Tags	157
Chopping Board	182	File Holder with Hanging Hook	Lot Dividers	149
Chrome Ring Binder Mechanisms	57	File Holder	Magnetic Clipboard	54
Circular Identification Tags	157	Filing Tray	Magnetic Multi-Purpose Holders	56
Cling Easy Whiteboard Material	65	Filtering Face Masks	Magnetic Pen Holders	29
Clip Point Blade	174	Flexible or Rigid Scraper	Mallet with Screw-in Faces	186
Clipboard Options	45	Flexible Scrapers	Mallet	185
Crimper	41	Floor Signs & Floor Sticker Signs	Mat	196
Cylinder Brush	132	Floor Signs	Measuring Cups & Measuring Spoons	115
Cylinder Brush for Long Handle	133	Floor Squeegee & Floor Scraper	Mechanical Pencils	29
Design Your Own Clipboard	46	Flour Scoops	Mini Spatulas	107
Desktop Calculator	33	Food Temperature Probe	Mouse Mat	37
Detectasil	191	Fully Detectable Economy Pen Refills	Multi-Purpose Dispenser	101
Detectortape	121	Fully Detectable Lanyards	Multi-Purpose Utility Stand	66
Dish Brush & Floor Brush	134	Fully Detectable Pen Refills Fine Tip Ink	Nail Brush	132
Disinfectant & Probe Wipe Dispenser Holder	123	Fully Detectable Pen Refills Standard Ink	Nitrile Gloves with Seamless Cuffs	72
Disinfectant Wipe Dispenser	118	Fully Detectable Pen Refills	Nitrile Gloves with Woven Cuffs	73
Disposable Aprons	90	Standard Ink	Normal Duty Safety Knife	169
Disposable Bag Cutters with Enclosed Blade	165	Fully Detectable Wrist Strap	Normal Duty Safety Knife with Enclosed Blade and Tape Cutter	169
Disposable Ear Plugs	82	Gasket Scraper & Dough Cutter	Normal Duty Safety Knives	170
Disposable Plastic Sheet Cutters with Enclosed Blade	167	Glasses Cord	Normal Duty Safety Knives with Dual Enclosed Blades and Tape Cutter	170
Disposable Ring Safety Knives	168	Glove Tensioners	Normal Duty Stainless Steel Safety Knife with Auto Retracting Blade	170
Disposable Safety Knives	164	Hairnets with Neck Guard	Nylon Cable Ties with Stainless Steel Lock	153
Disposable Safety Knives with Dual Enclosed Blades	166	Hairnets	Nylon Cable Ties	152
Disposable Safety Knives with Enclosed Blade	168	Hand Brush with Long Handle	O-Ring	193
Disposable Safety Knives with Enclosed Blade and Hook Blade	166	Hand Brush	PA6 Filled Nylon	195
Disposable Safety Knives	167	Hand Scrapers	Paddle without Holes	127
		Handheld Calculator	Palette Knives	182
		Handles	Pallet Band	147
		Hanging Clipboard		
		Hanging Hooks		
		HD One-Piece Pens		
		Health & Safety Signs & Floor Stickers		
		Heavy Duty Aluminium Safety Knife		
		Heavy Duty Clipboard Clips		

Paper Clips	40	Rulers	39	Tote Bin Covers	144
Paper	42	Safety Chains & Split Rings	40	Touch Screen Pens	28
Paring Knives	180	Safety Chains and Split Ring Attachments	11	Trigger Sprayer & Wipe Dispenser Holder	123
PDA Styluses	28	Safety Knife Applications	162	Turning Knives	179
PEEK	196	Safety Knife Features	163	UHMWPE	192
Pen Codes	15	Sampling Beakers	116	Ultra Lightweight Safety Glasses	94
Pen Dispenser	25	Sampling Cutlery & Sampling Cups	115	Utility Clips	96
Pen Tethers	11	Sanitiser Bottle Holder	125	Utility Hook	104
Permanent Fine Markers	27	Scissor Holders	37	Utility Pouch	38
Permanent Markers	26	Scissors	36	Vegetable Knives	178
Phone & Tablet Cases	34	Scouring Pad & Spray Bottle	128	Vinyl Gloves	70
Plasters/Bandages	77	Scraper with Stainless Steel	108	Wall Mountable Document Holder	60
Plastic Clipboard	49	Security Cage	183	Wall Mounted File Pocket	64
Plastic Glove Dispenser	76	Security Seals with Sequential Numbering	156	Wavy Edge Slicers	182
Plastic/Steel Paper Towel Holder	125	Security Seals	155	Whiteboard Eraser	29
Polypropylene Cable Ties	153	Serrated Edge Clips	53	Whiteboard Markers	27
Polythene Bags & Liners	146	Serrated Edge Flexible Scrapers	106	Zinc Plated Clips with Pen Holders	53
Polyurethane Belting	195	Shadow Board	158 - 160		
Pouring Jug & Scooping Jug	114	Sheepfoot Blade	174		
Prover Pocket	116	Shelf	124		
Pruning Blade	175	Shoe Covers	92		
PTFE	194	Short Handled Brush	133		
Push Broom	134	Shovel	126		
Recipe Holder	65	Silicone Rubber Sheeting, Strips and Extrusions	194		
Regular Pen Refills - Cryo Ink	13	Square Scoops	111		
Regular Pen Refills - Gel Ink	13	Stainless Steel Bucket with Lid	141		
Regular Pen Refills - Standard Ink	13	Stainless Steel Funnel	142		
Replacement Blades	163	Stainless Steel Glove Dispenser	75		
Resin-Set Brushes	129	Stainless Steel Measuring Jug	142		
Resin-Set Hand Brush with Medium Bristles	129	Stainless Steel Paddles & Forks	138		
Resin-Set Hand Brush with Stiff Bristles	130	Stainless Steel Pails	140		
Resin-Set Long Handled Brush	130	Stainless Steel Pharma Scoops	139		
Resin-Set Nail Brush	130	Stainless Steel Scoops	139		
Retractable 4 in 1 Pens	20	Stainless Steel Shovels and Spades	138		
Retractable Economy Pens	19	Stainless Steel Stick Pens	21		
Retractable Food and Meat Markers	24	Stainless Steel Whisk & Bowl	141		
Retractable Highlighter Refills	14	Staple-Free Stapler - 10 sheets	41		
Retractable Highlighters	23	Staple-Free Stapler - 7 sheets	40		
Retractable Permanent Fine Markers	24	Staple-Free Staplers - 5 sheets	42		
Retractable Permanent Markers	22	Stickers	63		
Retractable Stainless Steel Pens	21	Stirrer/Scraper	110		
Retractable Whiteboard Markers	23	Stopwatch	35		
Reusable Apron	90	Storage Box & Containers	117		
Reusable Earplugs 'Clean Ear' System	80	Storage Clipboard	66		
Reusable Earplugs 3 Flange	79	Storage Tray with Lid	120		
Reusable Earplugs 2 or 3 Flange	78	Swipe Card Holders	30		
Reusable Nitrile Gloves	74	Tabletop Squeegee	134		
Reusable Sleeve Covers	91	Tag Dispenser	151		
Reusable/Releasable Nylon Cable Ties	152	Tape Measure	39		
Ring Binder Clipboard	56	Temperature Probe Holder	35		
Ring Binder	58	Test Pieces	187		
Round Bowl Scoops	112	Timer	35		
Round Hand Brush	133	Tote Bin Cover Dispenser	143		
Rubber Bands	92				
Rubber Gloves	70				



# the **Blue Book** of etectable Products®

## **Detectamet UK**

Unit 1, Halifax Way  
Pocklington Industrial Estate  
York, YO42 1NR, UK

**T:** +44 1759 304200

**E:** sales@detectamet.com

## **detectamet.co.uk (£)**

---

## **Detectamet Canada**

Unit 13, 2295 Stevenage Drive  
Ottawa, Ontario  
K1G 3W1, Canada

**T:** +1-613-736-6560

**E:** sales@detectamet.ca

## **detectamet.ca (\$ CAD)**

---

## **Detectamet Germany**

Püllenweg 1-3, Korschenbroich  
41352, Germany

**T:** +492 161 9499 008

**E:** sales@detectamet.de

## **detectamet.eu (€)**

---

## **Detectamet USA**

5111 Glen Alden Drive  
Richmond, VA  
23231, USA

**T:** +1-804-303-1983

**E:** sales@us.detectamet.com

## **detectamet.com (\$ USD)**

---

## **Detectamet Australia**

Unit 2E, 128-130 Frances Street  
Lidcombe, Sydney  
NSW 2141, Australia

**T:** +61 2 9058 8555



**E:** sales@detectamet.com.au

## **detectamet.com.au (\$ AUD)**

## **detectamet.asia (\$ USD)**

---

## **Find us on:**

-  Detectamet
-  Detectamet
-  @Detectamet



**For updates & exclusive discounts,  
subscribe to our Detectamet newsletter  
at: [detectamet.global/signup](https://detectamet.global/signup) or scan the  
QR code.**

Detectamet accept no responsibility or liability for any errors or omissions in this catalogue. All information, including the approximate sizes, is provided in good faith and no warranty is given as to its accuracy. Detectamet reserves the right to alter, add or delete products featured in this catalogue and products may vary in design and finish from the ones displayed in this catalogue. All content is protected by copyright and cannot be reproduced without express permission.

